



The Perfect Fit for Asian Makes

Inside this booklet, you can find a selection of parts for some of the most important and iconic Asian vehicles, chosen from Blue Print's wide range

IN THIS EDITION



HYUNDAI & KIA
Popular compact-crossover SUV's
- page 10



TOYOTA Aygo
Excellent city runaround
- page 26



TOYOTA Hilux
Safety, strength and reliability
- page 28

Right First Time®

www.blue-print.com

bilsteingroup®

The Proof of Perfect Fit

With over 160 product types and more than 24,000 spare parts in range, including a heavy emphasis towards Asian vehicle makes, it is crucial that each and every one of these parts - from brake pads to timing belts - is the perfect fit.

Blue Print assures you of this; the thumbprint in the logo is our symbol of precision, uniqueness and quality. When perfection is achieved, we are happy to leave our mark - leaving a thumbprint is the Blue Print way of symbolizing this.

#theprooffperfectfit

Similar to how a thumbprint is unique to an individual person, Blue Print's thumbprint is unique to us as a brand and displays our values. Any time you see Blue Print's thumbprint, consider it our mark of approval. Since 1994, that approval is reached when perfection is achieved; only then is a product ready to be released. This is no more evident than within our core all-makes filtration, braking and clutch ranges. With OE-matching quality, you know you're getting the perfect fit.



Scan the QR code to watch our "The Proof of Perfect Fit" video

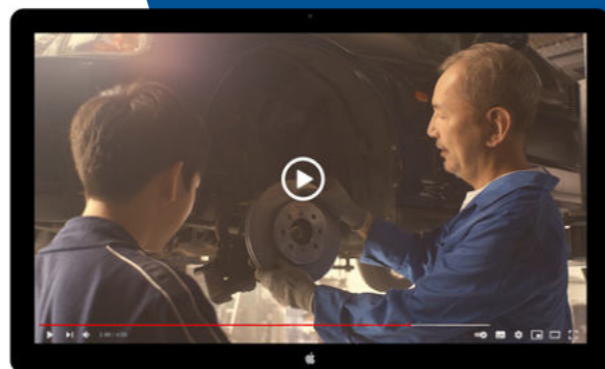

The Perfect Fit for Asian Makes

Blue Print's heavy focus on the Asian vehicle spare parts market provides solutions for over 20 vehicle manufacturers, from Toyota and Hyundai to Honda and Suzuki.

Our rapidly expanding range of OE-specification articles and the security of products being Right First Time® - assured with our 3-Year Manufacturer Guarantee - makes us a specialist for spare parts fitting Asian vehicle makes you can rely on.

Blue Print parts are available to fit the following Asian vehicle manufacturers:

- Asia Motors
- Daihatsu
- Hino
- Honda
- Infiniti
- Isuzu
- Lexus
- Mazda
- Mitsubishi/Fuso
- Nissan
- Subaru
- Suzuki
- Toyota
- Chevrolet
- Daewoo
- Hyundai
- Kia
- SsangYong
- Perodua
- Proton
- Chery
- Great Wall
- Tata

With one of the largest range of parts, Blue Print is the right choice for all Asian vehicle requirements. Whether it's old or new, top-selling or niche low volume, we have a comprehensive offering of products available.

This booklet illustrates a selection of Blue Print products for some of the most important and iconic Asian vehicles - from SUVs such as the Hyundai Tucson and Kia Sportage, to sporty sedans such as the Mitsubishi Lancer Evolution and Subaru Impreza.

However, this is only a very small sample of our range. Whether you're looking for a water pump for a Great Wall Hover or a brake pad for an Isuzu Bighorn, trust in Blue Print to find what you're looking for as a specialist for Asian vehicle parts in the Independent Aftermarket.

Our extensive product portfolio covers everything you could possibly need:



Filtration



Engine Management



Electrics



Braking



Drivetrain



Body & Interior



Clutch



Engine Timing



Specialist Tools



Steering & Suspension



Engine Thermal Management



Solutions

The Blue Print Manufacturer Guarantee: Our Quality Promise – Your Added Value

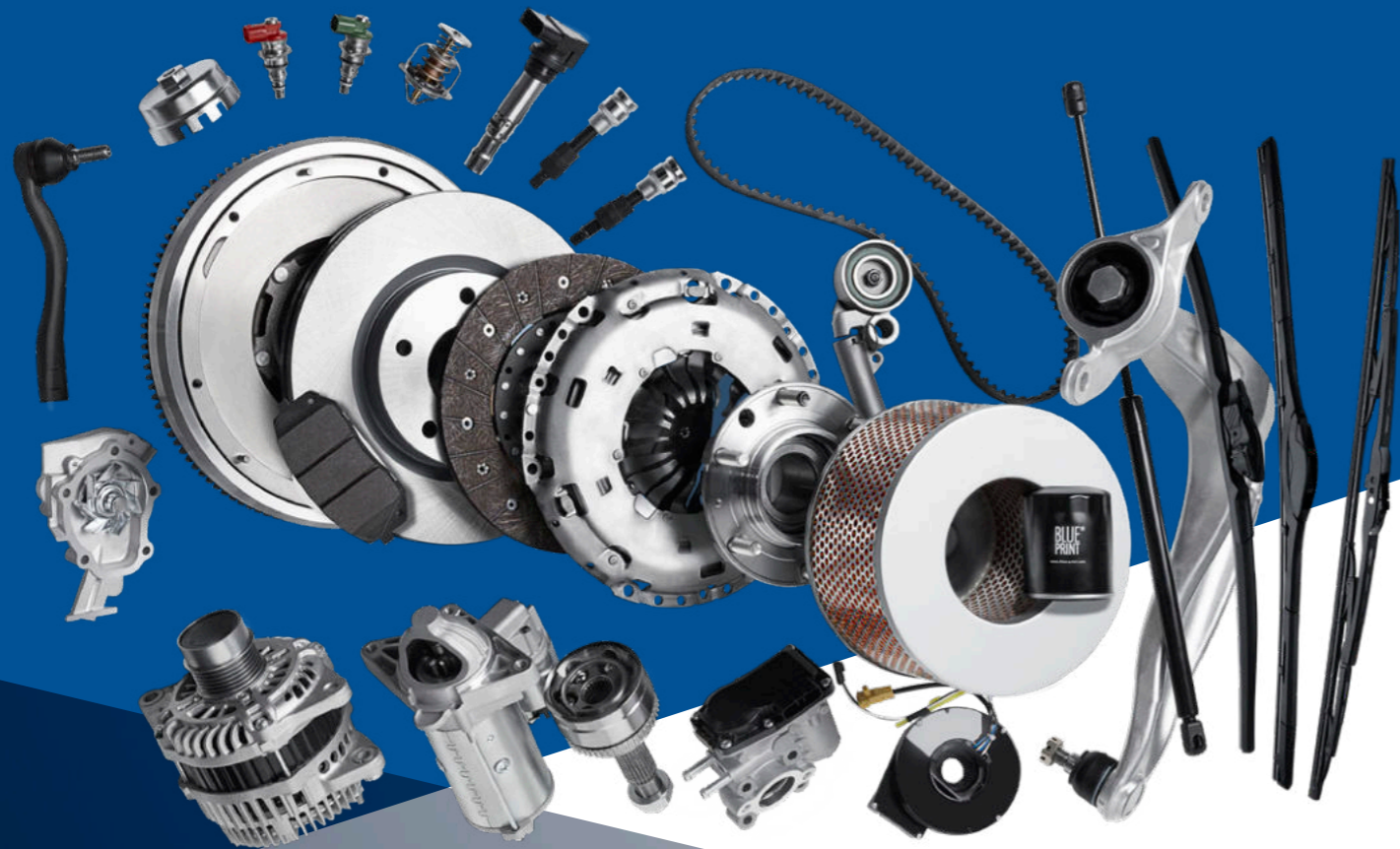

Blue Print exclusively offers its customers replacement parts in OE-matching quality. As a specialist with manufacturing competence, we only provide products with a high degree of installation safety and durability.

In order to underline our high product quality standards, we are providing a 3-Year Manufacturer Guarantee for all of our replacement parts.

This is our commitment to quality and is a real added value for everyone who trusts Blue Print products - from wholesalers to workshops.

All details regarding Blue Print's 3-Year Manufacturer Guarantee can be found here: www.blue-print.com/3



bilsteingroup® partsfinder





SEARCHING BECOMES FINDING



Parts Search

Made Easy

partsfinder provides direct access to over 62,000 replacement parts from the bilstein group. You can find the component you are looking for with just a few keywords.

-  **Simple Direct Search**
Search field makes finding results easy and effective
-  **Detailed Product Information**
Including repair set references & safety data sheets
-  **Customized Article Lists**
Combine individual articles & print them as a PDF with just a single click
-  **Expert Filter**
Find your parts even easier
-  **B2B Shop**
Check availability of any article (selected customers only)

Register now for free
partsfinder.bilsteingroup.com

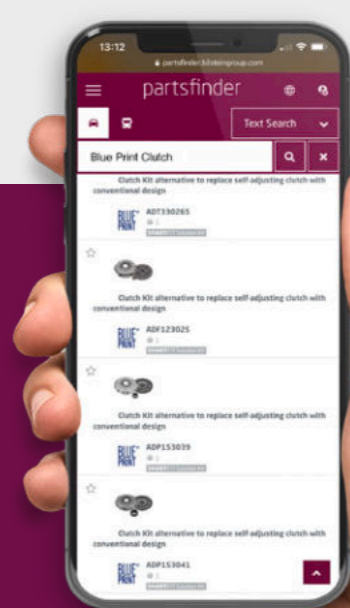



FANS
Future Article
Notification System



HONDA Jazz

The Honda Jazz - also known as the 'Fit' in many parts of the world - has been around since 2001 and is now in its fourth generation. This five-door, front-engine hatchback is one of the Japanese manufacturer's smaller offerings, with a one-box (monospace) design, configurable seats for extra luggage space (to compete with larger vehicles), and boasting full hybrid capabilities with the latest edition.

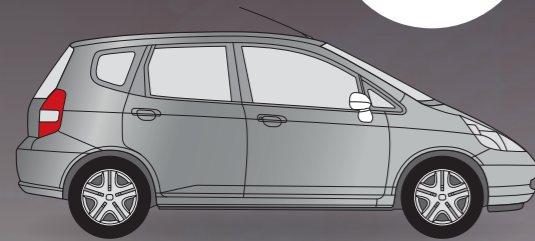
The current hybrid models are mainly popular in Europe - having been phased out of markets such as North America and Australia - but any model of Jazz has always been a popular choice for those who want a small, economical and value for money 'runaround'. It is also noted for its impressive reliability.



Jazz I (GD1) 2002>2008

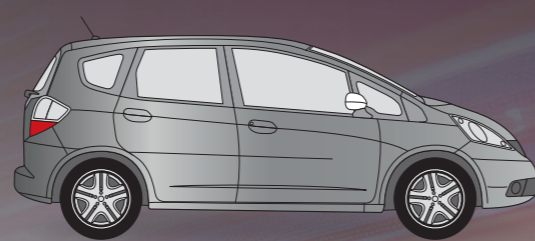

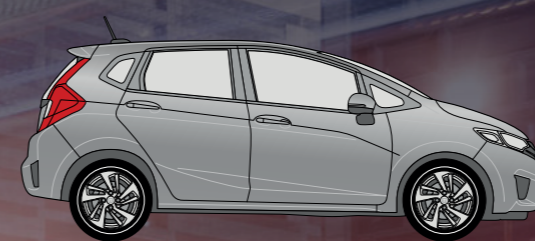

Jazz II (GE6) 2008>2015



Jazz III (GK3) 2013>



Jazz IV (GR3) 2020>



Auxiliary Belt
AD05R1138/53/
AD06R1140





Clutch Kit
ADBP300159/
ADH230109



Timing Chain Kit
ADBP730038/65

CV Boot Kit
ADH28116/68

Wheel Bearing Kit
ADH28241/354





ABS Sensor
ADH27189/91





Brake Pad Set
ADH24285/6



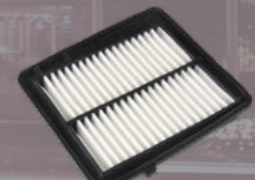

Brake Disc
ADH243114/5

Oil Filter
ADH22114

Air Filter
ADBP220067

Cabin Filter
ADH22515

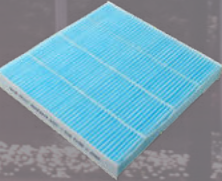



Control Arm
ADH28692/93/94/95/96/97





Stabiliser Link
ADH28541/42/43/44



Control Arm Bush
ADH280158

Thermostat
ADH29214C

Water Pump
ADH29154



Strut Mounting
ADBP800174



Strut Mounting Kit
ADBP800173





Wiper Blade
AD14FL350/AD15FL380/AD24FL600/AD26FL660



Oil Pressure Sensor
ADH26609

bilsteingroup®
partsfinder



Scan the QR code or click the link to see the full range of parts available for the Honda Jazz on partsfinder.bilsteingroup.com

Blue Print has over 200 parts in range for the Honda Jazz; presented above is a selection of these parts for the Honda Jazz I / II / III / IV

HONDA CR-V



Introduced in 1996, Honda's compact-crossover SUV is now in its fifth generation; the latest model being a full self-charging hybrid. The CR-V stands for 'comfortable runabout vehicle', utilising the Civic platform with an SUV design.

The CR-V is a very popular choice for families, especially in the North American market. Customers enjoy its spacious cabin, comfortable ride, reliability and its eco-friendly nature - particularly with the latest hybrid edition. The car also sits relatively high off the ground, making it a good choice for off-road escapades.

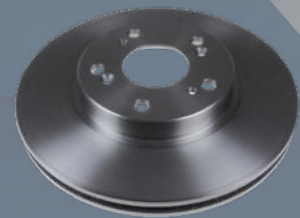

Brake Disc
ADH24373/87/88/91



Brake Pad Set
ADH24247/65/80



Clutch Cover
ADH23266N



Clutch Release Bearing
ADH23318



Clutch Disc
ADH23163



Timing Chain Kit
ADH27336

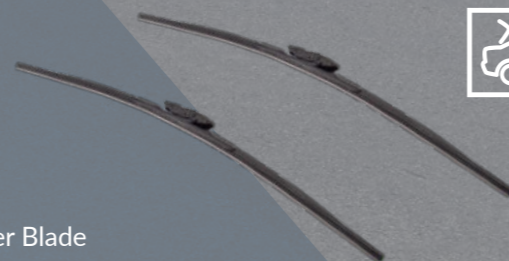

Wiper Blade
AD20FL500/AD21FL530



Wheel Bearing Kit
ADH28230/231/337



Radiator Cap
ADH29902



Water Pump
ADH29143



Engine Mounting
ADH280139



Transmission Mount
ADH280142



Knock Sensor
ADBP720000



Ignition Coil
ADH21478



Lambda Sensor
ADBP700113/
ADH27046



Inner Tie Rod
ADH28732



Tie Rod End
ADH28719



Anti Roll Bar Bush
ADH28035/36/37



Fuel Filter
ADH22335C



Transmission Oil Filter
ADBP210014



Starter Motor
ADH212509

Blue Print has over 400 parts in range for the Honda CR-V; presented above is a selection of these parts for the Honda CR-V II 4WD (RD8)

bilsteingroup
partsfinder



Scan the QR code or click the link to see the full range of parts available for the Honda CR-V on partsfinder.bilsteingroup.com

HYUNDAI TUCSON & KIA SPORTAGE

Hyundai and Kia's close relationship is very evident when looking at their popular compact-crossover SUVs, the Tucson and Sportage. Hyundai's Tucson - named after the city in Arizona - is the Korean manufacturer's best-selling SUV and has been in production since 2004, whilst Kia launched the Sportage name in 1993 but the shared-platform Tucson equivalent entered the market in 2005. The Tucson and Sportage are unique to one another, but the shared base platform is clear to see.

The Sportage was Kia's best-selling vehicle in 2016 and it's not hard to see why: both the Sportage and Tucson (also known as the ix35 for the 2010-2015 models) have been praised for their design quality, reliability and size. This year, the Tucson has stepped into hybrid territory with its radically different fourth-generation version, and the Sportage follows suit next year. Both models have undergone a facelift and feature hybrid and plug-in hybrid capabilities.

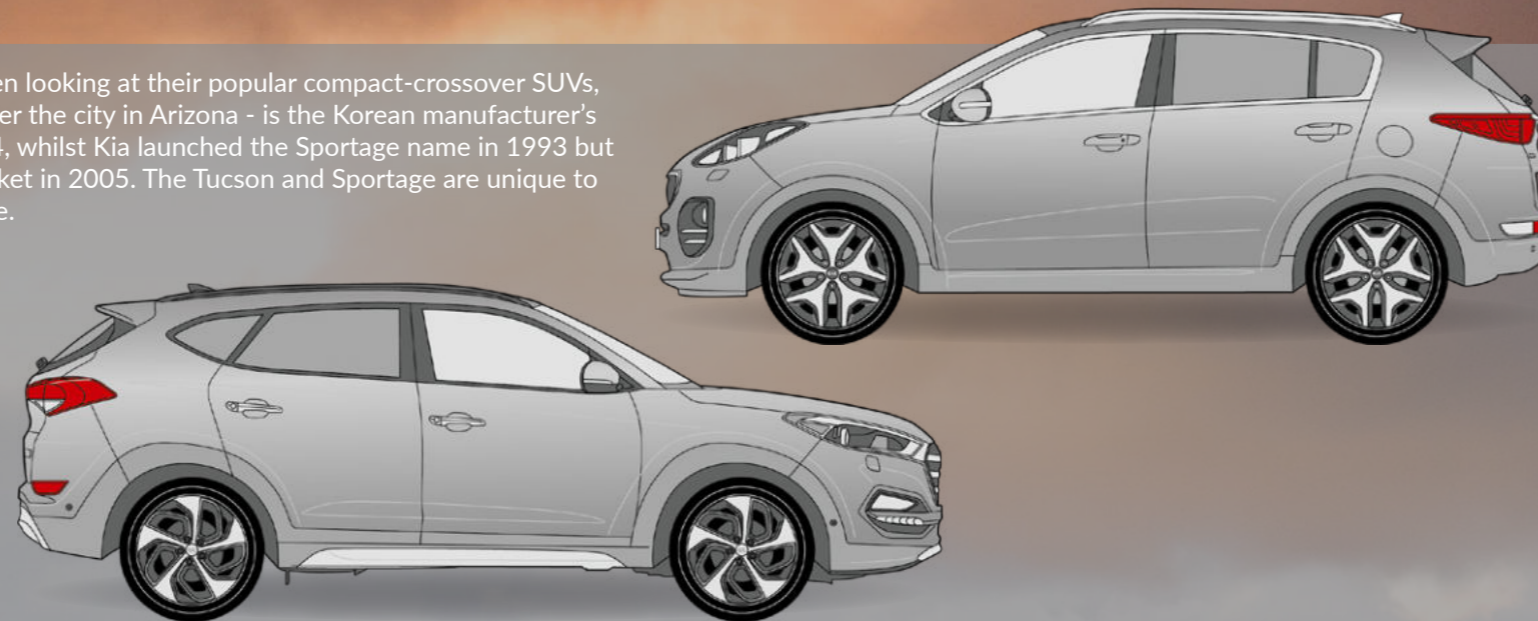

Air Filter
ADG022155



Fuel Filter
ADBP230009/ADG02392



Transmission Oil Filter Set
ADBP210078



Brake Disc
ADG043221/22/23



Brake Pad Set
ADG042127/69/79



Auxiliary Belt
AD06R2412



TVD Pulley
ADBP610001



Strut Mounting Kit
ADBP800306



Flexible Disc
ADG080323



Camshaft Sensor
ADG07242



Wheel Bearing Kit
ADG083105



Timing Chain Kit
ADBP730012



Concentric Slave Cylinder
ADG03648



Thermostat
ADT39209



Water Pump
ADG09185



Control Arm Bush
ADBP800092/349/360



Inner Tie Rod
ADBP870027



Washer Pump
ADG00307

bilsteingroup®
partsfinder



Scan the QR code or click the link to see the full range of parts available for the Kia Sportage on partsfinder.bilsteingroup.com



Scan the QR code or click the link to see the full range of parts available for the Hyundai Tucson on partsfinder.bilsteingroup.com

Blue Print has more than 500 parts in range for the Kia Sportage and over 400 parts for the Hyundai Tucson; presented above is a selection of parts common to the Kia Sportage IV 4x4 and the Hyundai Tucson III 4x4

LEXUS LS

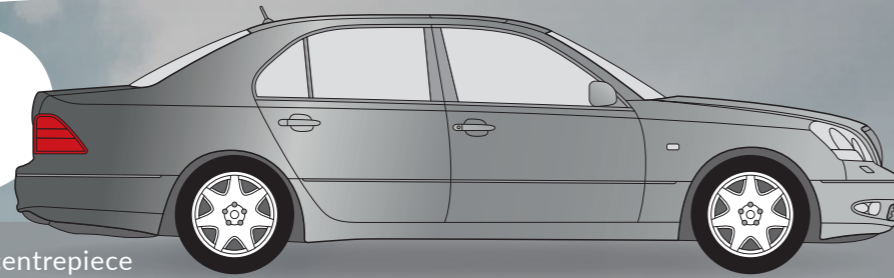

The Lexus LS (luxury sedan) is the centrepiece of the Lexus brand, which was introduced back in 1989 as the 'luxury' division of Toyota. The first four generations of LS were mainly rear-wheel-drive V8s, before the 2017 release of the fifth-generation model featured a V6. With so many models produced over a long period of time, the LS has gone through massive transformations and, to this day, is a major competitor in the luxury saloon car market.

The original 1989 'LS 400' sold strongly and is widely known to be the main trigger for Lexus's success as a brand. The more recent LS' are known for their sleek looks and hybrid/electric capabilities, but many people consider Lexus' efforts do not quite reach the style and heritage of European counterparts such as Audi, BMW and Mercedes.

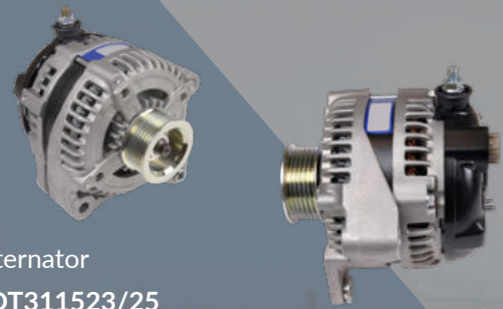

Alternator
ADT311523/25



Ball Joint
ADT386139/40

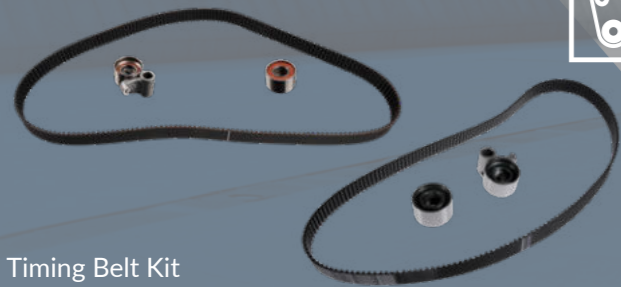

Timing Belt Kit
ADBP730055/ADT37317



Inner Tie Rod
ADT387204



Tie Rod End
ADT387120



Wiper Blade
AD16FL400/AD24FL600



Wheel Bearing Kit
ADT383117



Brake Hose
ADT353256



Brake Pad Set
ADT342125/26

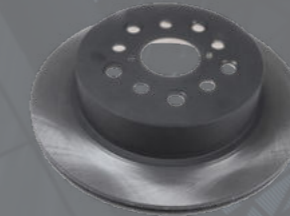

Brake Disc
ADT343182C/215

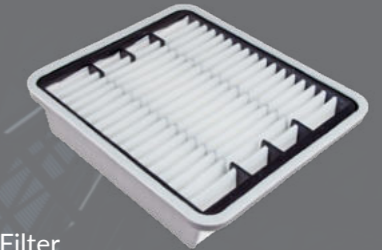

Air Filter
ADT32271

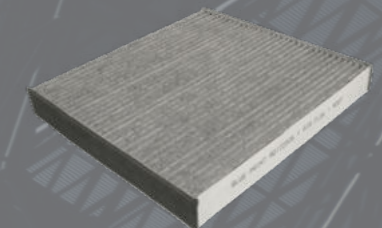

Cabin Filter
ADT32506/21



Thermostat
ADT39209



Water Pump
ADT39161/81



Fuel Filter
ADT32375C



Oil Filter
ADT32114



Lambda Sensor
ADBP700021



Air Flow / Mass Meter
ADT374202C



Auxiliary Belt
AD06R2240



Rocker Cover Gasket
ADT36781

Blue Print has more than 170 parts in range for the Lexus LS; presented above is a selection of these parts for the Lexus LS III 430 (UCF3)

bilsteingroup
partsfinder



Scan the QR code or click the link to see the full range of parts available for the Lexus LS on partsfinder.bilsteingroup.com

MAZDA

MX-5

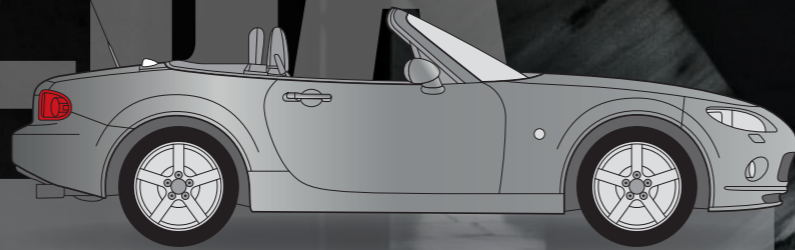

The MX-5 is undoubtedly one of the most globally-recognizable and successful sports cars of all time. Unveiled in 1989 with the Lotus Elan as its inspiration, the MX-5 is Japan's answer to the sleek, lightweight and minimalistic design utilised in the Lotus. Production exceeded one million in 2016 and, to this day, the MX-5 - also known as the Miata in some markets - still continues to adapt and evolve with the times.

The first generation (NA) MX-5 spanned eight years and was an instant hit worldwide; generation two covered nearly as long, until the third edition MX-5 hit the ten-year mark with a production span from 2005 to '15. The latest model, the MK4, won World Car of the Year in 2016 and is also the base for the Fiat 124 Spider. What made the original MX-5 popular is still present in today's version: it looks good, handles well, it's practical, reliable and economical, and relatively cost-effective.



Chain for Oil Pump
ADM561506



Timing Chain
ADM57333



Radiator Cap
ADZ99901



Thermostat
ADM59218/20



Wheel Bearing Kit
ADM58226/37



CV Boot Kit
ADM58176



Inner Tie Rod
ADM58791

Tie Rod End
ADM58754



Camshaft Sensor
ADM57220

Crankshaft Sensor
ADM57211



Brake Cable
ADM546115/16



Clutch Kit
ADM530107/108



TVD Pulley
ADM56117

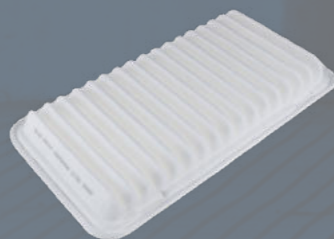

Air Filter
ADM52254

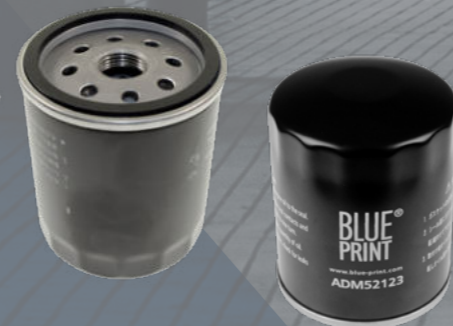

Oil Filter
ADM52118/23

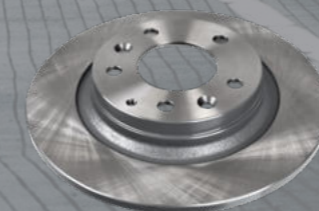

Brake Disc
ADM54360/398



Brake Pad Set
ADM54290/91



Gas Spring
ADM55805

Blue Print has over 200 parts in range for the Mazda MX-5; presented above is a selection of these parts for the Mazda MX-5 III (NC)

bilsteingroup®
partsfinder



Scan the QR code or click the link to see the full range of parts available for the Mazda MX-5 on partsfinder.bilsteingroup.com

MITSUBISHI LANCER EVO VS. SUBARU IMPREZA

These two Japanese giants are well-known titans of global car culture. They both launched in 1992 and since then have gone head-to-head in both road car and rallying circles. Mitsubishi's Lancer 'Evolution' ceased production in 2016 but went through ten 'evolutions' in its lifecycle and was a hugely popular road car, known for its aggressive looks, impressive torque and association with rallying - in which it was successful in the world championship from '96 to '99. Subaru's Impreza was also successful in the same championship and picked up a number of manufacturer and driver titles.

Unlike Mitsubishi, Subaru is still producing new Impreza models to this day. Now in its fifth generation, the Impreza is sold in multiple configurations - a five-door hatchback and four-door saloon are available - and there's also a performance-based 'WRX' rally edition in the market. The Evo vs. Impreza battle still rumbles on and opinions are varied, but both cars are major players in the automotive industry and have left their mark on rallying as well.

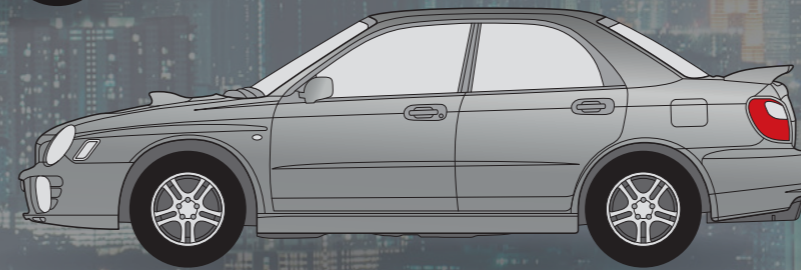
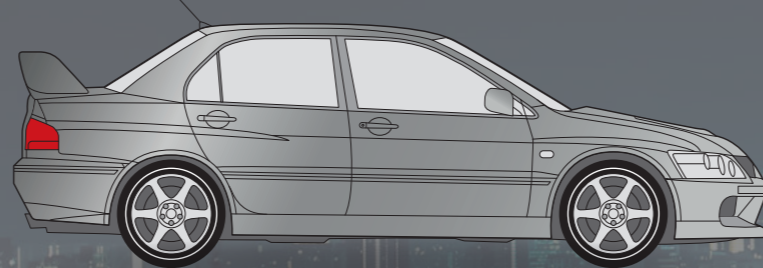

Timing Belt Kit
ADS77309

Brake Disc
ADS74308/13

Brake Pad Set
ADS74219/ADS74220/34

Fuel Filter
ADC42337

Cabin Filter
ADC42507

Clutch Kit
ADC43097

Timing Belt Kit
ADC47339C

Wheel Bearing Kit
ADC48250/353

Water Pump
ADS79110

Clutch Kit
ADS73037

Fuel Filter
ADS72305

Cabin Filter
ADS72501

Brake Pad Set
ADC44250/55/64/
ADS74229

Brake Disc
ADC44366/70/85

Water Pump
ADC49155C

Inner Tie Rod
ADC48796

Tie Rod End
ADC48768

bilsteingroup®
partsfinder

Scan the QR code or click the link to see the full range of parts available for the Mitsubishi Lancer on partsfinder.bilsteingroup.com

Tie Rod End
ADS78707

Inner Tie Rod
ADS78714/15/19

Wheel Bearing Kit
ADS78206/304/313/319

bilsteingroup®
partsfinder

Scan the QR code or click the link to see the full range of parts available for the Subaru Impreza on partsfinder.bilsteingroup.com

Blue Print has more than 150 parts in range for the Mitsubishi Lancer Evolution; presented above is a selection of these parts for the Mitsubishi Lancer Evolution IX 4x4

Blue Print has more than 300 parts in range for the Subaru Impreza; presented above is a selection of these parts for the Subaru Impreza II (G11)

mitsubishi PAJERO

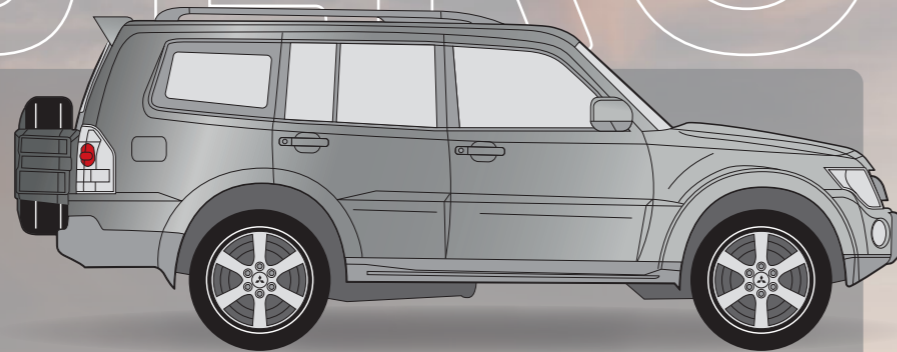

The Pajero (also known as the Shogun and Montero) is a full-size SUV introduced by Mitsubishi in 1981. The first model was unique at the time for featuring a turbocharged diesel engine, double-wishbone suspension and power steering. The Pajero's second-generation launched in 1991 and ran until '99, with generation three following until 2006.

At this point, the Pajero was discontinued in North America but continued elsewhere until its ultimate demise in 2021, partly due to the COVID pandemic. The Pajero was always known as a strong, reliable 4x4 but - as the market for SUVs gained momentum - its off-road abilities were over shadowed by the cumbersome handling, poor performance and outdated interior, according to reviewers.



Ball Joint
ADC48667/70/88

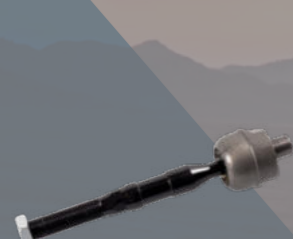

Inner Tie Rod
ADC48792



Tie Rod End
ADC48789/90



Automatic Transmission Fluid (ATF)
ADG05532



Wiper Blade
AD20HY500/AD22HY550



EGR Valve
ADBP740015



Camshaft / Crankshaft Sensor
ADC47214C

Dual-Mass Flywheel
ADC43503C

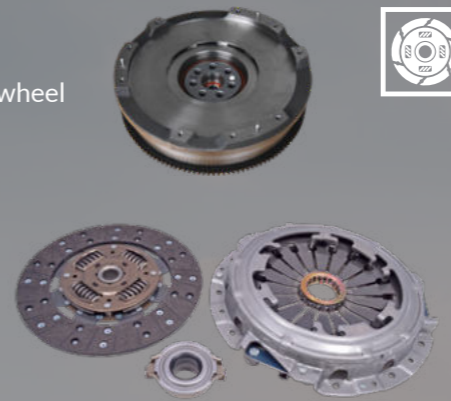

Clutch Kit
ADC43098

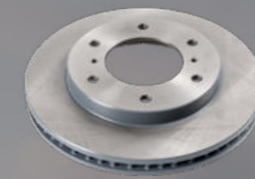

Brake Disc
ADC443110/
ADC44379



Brake Pad Set
ADC44259/61

Water Pump
ADC49170



Radiator Cap
ADC49909/ADZ99901



Oil Filter
ADC42127



Transmission Oil Filter Set
ADBP210080



Glow Plug
ADC41819



Starter Motor
ADC412505

V - Belt
AD10V950/
AD13V900



TVD Pulley
ADC46114



Wheel Bearing Kit
ADC48253/357



Universal Joint
ADC43903



Blue Print has more than 700 parts in range for the Mitsubishi Pajero; presented above is a selection of these parts for the Mitsubishi Pajero IV 4x4 (V88W)

bilsteingroup®
partsfinder



Scan the QR code or click the link to see the full range of parts available for the Mitsubishi Pajero on partsfinder.bilsteingroup.com

NISSAN MICRA

The Micra is a common sight on roads worldwide as this popular, small hatchback offers practicality and simplicity on a low budget. It's been around since 1982 and was always seen as a cheap 'runaround', or a 'learner driver' car, but the latest models have a sportier edge to them; the Micra has been through huge changes in its five-generation history.

The second and third-generation Micras (spanning '92-'03 and '03 to '10 respectively) are some of the more recognisable Micras on the road. They were unspectacular but cheap, efficient and an ideal 'runaround'. The Micra began to change more drastically in the fourth generation, and by the time generation five came around (2016) it had little resemblance to its predecessors. The Micra now competes with other popular 'superminis' like the Ford Fiesta, SEAT Ibiza, VW Polo and Renault Clio (which it shares an engine with). It's less economical now, and more expensive, but boasts sleek looks inside and out, it's easy to drive, and still holds onto its practical nature.

NISSAN

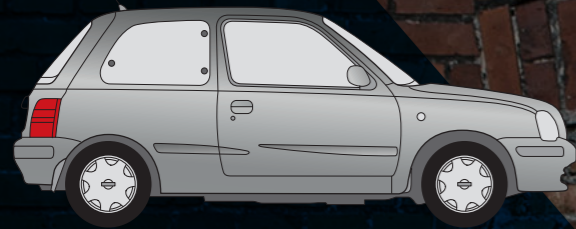

Micra II (K11E) 1992>2003



Micra III (K12E) 2003>2010

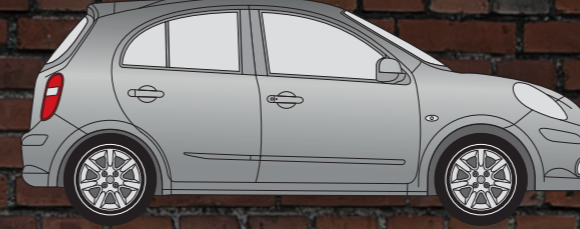

Micra IV (K13K) 2010>2015



Micra V (K14FR) 2016>

Washer Pump
ADN10323/24

Gas Spring
ADN15806

Timing Chain Kit
ADBP730022/
ADN173506

Clutch Kit
ADN13013/77

Ignition Coil
ADN11477C

Pressure Switch
ADBP270000

Wheel Bearing Kit
ADN18269/382

CV Boot Kit
ADT38107

Brake Pad Set
ADBP420083/ADK84236

Brake Disc
ADN143112

Strut Mounting
ADN180504/05

Engine Mounting
ADN180132/ADN18083/85

Ball Joint
ADBP860027

Control Arm Bush
ADBP800004

Tie Rod End
ADN187226/27

Auxiliary Belt
AD04R800/AD07R1179

Oil Filter
ADN12121/34

Air Filter
ADN12291

Blue Print has over 400 parts in range for the Nissan Micra; presented above is a selection of these parts for the Nissan Micra II / III / IV / V

bilsteingroup®
partsfinder



Scan the QR code or click the link to see the full range of parts available for the Nissan Micra on partsfinder.bilsteingroup.com

NISSAN CABSTAR

This 'cab-over-engine' truck first appeared in 1968 and was exclusive to the Japanese market, but by the 1980s the next generation - known as the 'Atlas' - made its way to the global market. The 'Cabstar' name was utilised in Europe and the truck was a particular success in France, Italy, Spain and the UK thanks to its reliability, weight-carrying potential, and relatively small size.

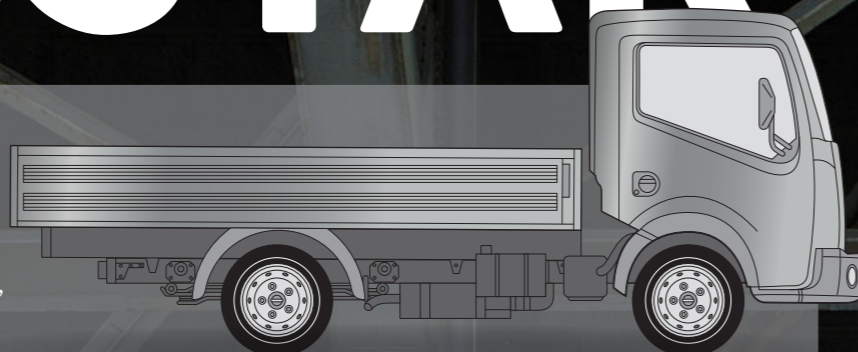

Over time, the truck has gone through many editions and name changes specific to different markets, but still upholds its reputation as being durable and strong, with a solid engine and a high level of manoeuvrability.



Lambda Sensor
ADBP700110

Air Flow / Mass Meter
ADN174203C



Thermostat
ADC49206

Water Pump
ADN19179C/88C



Washer Pump
ADN10311



Stabiliser Link
ADN18537

Leaf Spring
ADN18822



Brake Disc
ADBP430110/
ADN143123/31/32/35/51

Brake Pad Set
ADN142133/34/41/59



Air Filter
ADN12254

Fuel Filter
ADN12333/40



Clutch Kit
ADBP300016/49/
ADN130228/29/30

Dual-Mass Flywheel
ADN13511C



Timing Chain Kit
ADN17353



Universal Joint
ADN13912/13

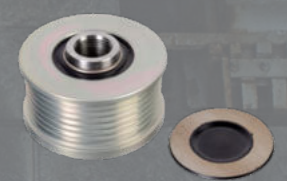

Alternator Overrun Pulley
ADN161304/06

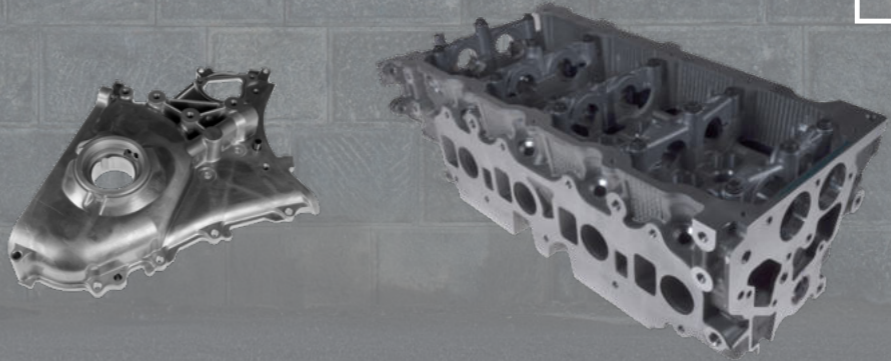

Oil Pump
ADN16134

Cylinder Head
ADN17709

Blue Print has more than 300 parts in range for the Nissan Cabstar; presented above is a selection of these parts for the Nissan Cabstar III (F24M) (3.0+2.5)

bilsteingroup®
partsfinder



Scan the QR code or click the link to see the full range of parts available for the Nissan Cabstar on partsfinder.bilsteingroup.com

SUZUKI SWIFT

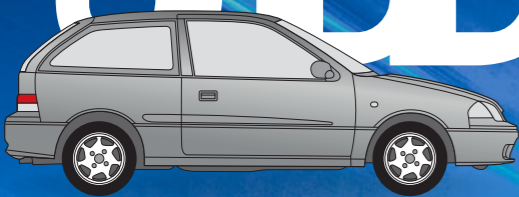

Swift II (SF41) 1989>2003

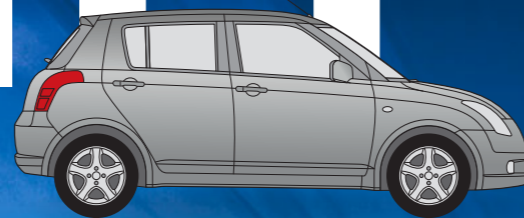

Swift III (RS41) 2005>2012

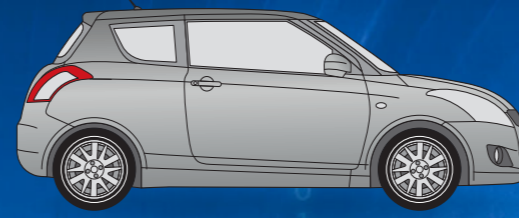

Swift IV (AZG4) 2010>2017

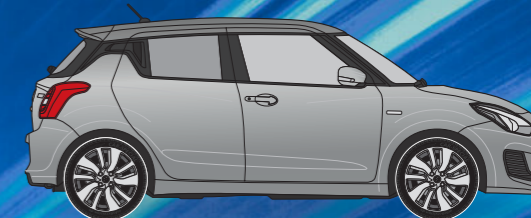

Swift V (A2L4) 2017>

Suzuki's popular subcompact/hot hatch, the Swift, has been in production since 1983. At that time, it was also known as the Cultus in Japan, before the Swift name fully took over in 2000. The third-generation Swift was the first of the new 'sportier' variants, launching in 2005 to great success. Generation four ran from 2010-17 and the fifth edition is still in circulation today. An upgraded Swift 'Sport' model was introduced in late 2005 as a more performance-based option.

The latest model Swift is known for retaining its original small size (as its competitors have grown over the years), hybrid capabilities, cheaper than some rivals such as the Ford Fiesta, strong reliability and sharp handling.

Clutch Kit
ADK83010/64

CV Boot Kit
ADH28129/30/
AK88103/53/60
ADN18106

Wheel Bearing Kit
ADK88211/13/20/
ADK88302/06

Ignition Coil
ADK81475/81

EGR Valve
ADK87208

Strut Mounting
ADBP800140/334/335

Inner Tie Rod
ADK88742

Stabiliser Link
ADK88509

Timing Chain Kit
ADBP730036/82

Alternator Overrun Pulley
ADK861302

Water Pump
ADK89124

Thermostat
ADK89214

Auxiliary Belt
AD04R763/AD05R897

Gas Spring
ADBP580016

Wiper Blade
AD18HY450/AD21HY530

Air Filter
ADK82255

Cabin Filter
ADK82517

Oil Filter
ADK82108

Brake Disc
ADK84349/52

Brake Pad Set
ADK84238/ADM54295

Blue Print has over 300 parts in range for the Suzuki Swift; presented above is a selection of these parts for the Suzuki Swift II / III / IV / V

bilsteingroup®
partsfinder



Scan the QR code or click the link to see the full range of parts available for the Suzuki Swift on partsfinder.bilsteingroup.com

TOYOTA AYGO



Toyota's Aygo citycar, first introduced in 2005, assembled alongside its relations the Citroen C1 and Peugeot 107/108 and shares many components and design features with those models, was a joint venture to share development costs. The Aygo is in only its second generation; various facelifts were executed in the first, but it took until 2014 for a full redesign.

With only a one-litre petrol engine available in Europe, and 71bhp on offer, the latest edition Aygo is slightly punchier than the original model's 68bhp - but not by much! With a low price tag, excellent reliability, strong MPG figures and being a size suitable for even the smallest parking spaces, the Aygo is an excellent choice for a city runaround.

Stabiliser Link
ADT38590



Anti Roll Bar Bush
ADT380127



Tie Rod End
ADT387171/72



Strut Mounting Kit
ADBP800123

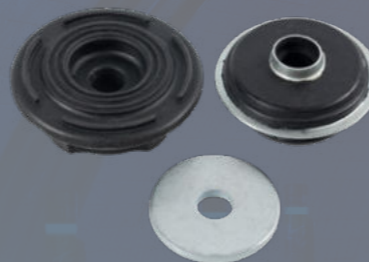

Timing Chain
ADT37350



Clutch Kit
ADT330299



Ignition Coil
ADT31494



Coolant Temperature Sensor
ADT37226



Brake Disc
ADT343198



Brake Pad Set
ADT342155

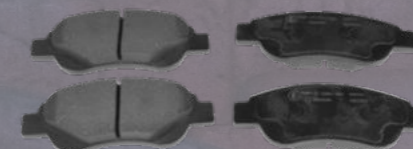

Wheel Cylinder
ADT344104



Air Filter
ADT322115

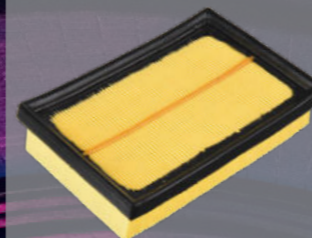

Oil Filter
ADT32109



CV Boot Kit
ADT381110



Wheel Bearing Kit
ADT38290/370



Auxiliary Belt
AD06R1206/20

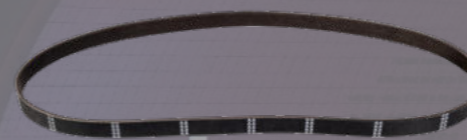

Alternator Overrun Pulley
ADT36127/28



Gas Spring
ADBP580010



Radiator Cap
ADH29902



Thermostat
ADD69215



bilsteingroup®
partsfinder



Scan the QR code or click the link to see the full range of parts available for the Toyota Aygo on partsfinder.bilsteingroup.com

Blue Print has more than 140 parts in range for the Toyota Aygo; presented above is a selection of these parts for the Toyota Aygo II (KGB40)

TOYOTA HILUX



Introduced in the late 1960s, the Hilux pickup is a mainstay of the brand and more than 18 million have been produced since '68; yet not always under the Hilux name, as the North American market embraced the rather straightforward 'Toyota Pickup' title for models sold between 1972 and 1995.

Naming differences aside, the Hilux has gone through eight makeovers in its time, and the current generation model - introduced in 2015 - is commonly known as one of the best pickups available, and a further continuation of the Hilux's reputation as being tough and reliable even in the harshest conditions.

Reviews for the latest Hilux praise its safety, strength and reliability as well as the comfortable ride and spacious cabin and load areas. On the engine front, it is slightly less powerful than rivals such as the Ford Ranger, but the Hilux is designed more to be a daily driver rather than 'just' a pickup truck. An EV-model Hilux has been announced, but a timeline of its release is uncertain.

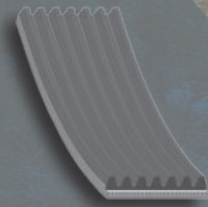

Auxiliary Belt
AD07R1094/515



Crankshaft Sensor
ADT37254



Suction Control Valve
ADT36853



Thermostat
ADT39211



Water Pump
ADBP910003/ADT391110/ADT39151

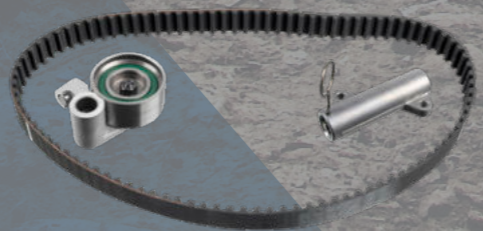

Timing Belt Kit
ADBP730046/47/ADT37310/22



ABS Sensor
ADT37170



Brake Drum
ADT34719



Brake Shoe Set
ADT34174

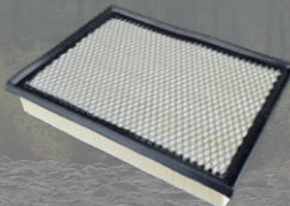

Air Filter
ADT322130

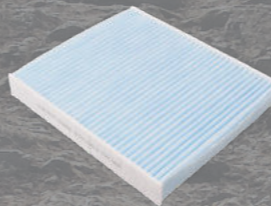

Cabin Filter
ADT32551/52

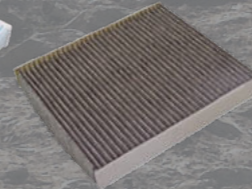

Oil Filter
ADT32108



Fuel Filter
ADT323104



Control Arm
ADBP860044/45



Stabiliser Link
ADT38566/67



Bump Stop
ADT380194

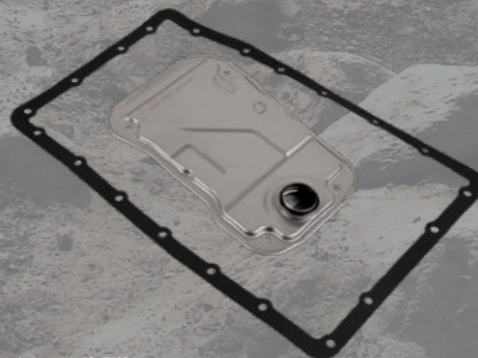

Transmission Oil Filter Set
ADT32144



Wiper Blade
AD16HY400
AD22HY550



bilsteingroup
partsfinder



Scan the QR code or click the link to see the full range of parts available for the Toyota Hilux on partsfinder.bilsteingroup.com

Blue Print has over 600 parts in range for the Toyota Hilux; presented above is a selection of these parts for the Toyota Hilux VIII 4x4 (KUN125)

TOYOTA PRIUS

The Prius was revolutionary when it launched in Japan in 1997 as the first mass-produced hybrid vehicle. It made its way onto the international market at the turn of the century and, in the 22 years since then, continues to be a world leader in hybrid motoring. They are a very common sight on roads globally.

Now in its fourth generation, the Prius' popularity can be associated to its impressive fuel economy, spacious and comfortable cabin, low running costs, reliability and safety, and ease of driving. It's a particularly popular choice for ride-sharing platforms and company cars, too.

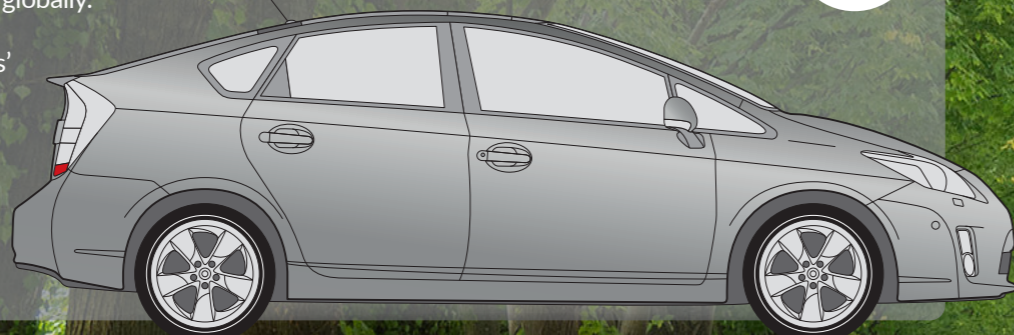

Ball Joint
ADT386202

Control Arm
ADBP860015/16

Stabiliser Link
ADT38580

ABS Sensor
ADBP710049/71

Brake Disc
ADT343135/3277

Brake Pad Set
ADT342167/2181/2204

Gas Spring
ADT35826

Lambda Sensor
ADBP700021

EGR Valve
ADBP740009

Manifold Pressure Sensor
ADBP720019/ADT374211

Timing Chain
ADT37346

Bump Stop
ADT38459

Wheel Bearing Kit
ADT38293/ADT383115

Coolant Hose
ADBP930002/4

Water Pump
ADT391116

Air Filter
ADT322110

Oil Filter
ADD62109/ADT32109

bilsteingroup
partsfinder

Scan the QR code or click the link to see the full range of parts available for the Toyota Prius on partsfinder.bilsteingroup.com

Blue Print has over 200 parts in range for the Toyota Prius; presented above is a selection of these parts for the Toyota Prius III (ZVW30)

TOYOTA COROLLA

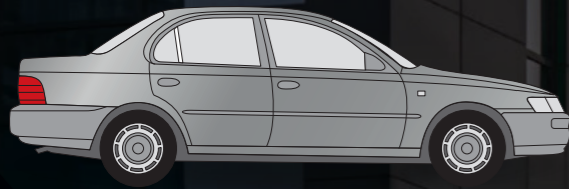

Corolla VI (AE92) 1987>1994



Corolla VIII (EE111) 1997>1999

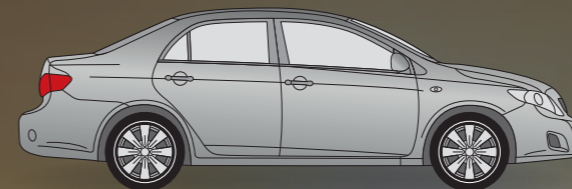

Corolla X (ZRE151) 2006>2014



Corolla XII (MZE12) 2018>

The Toyota Corolla is one of the most successful range of cars ever produced. First introduced way back in 1966, there have been as many as 12 generations of Corolla in that time and by 2021, the model hit its 50 million sales milestone, making it the current best-selling passenger vehicle of all time. The Corolla was classed as a subcompact car from 1966 to 1991, before a size overhaul in '91 (for the seventh generation) put it into the compact category.

The latest Corolla, generation 12, is available in three forms: hatchback, station wagon and sedan (popular in North America, known as the Avensis in the UK). Each market has different versions available to them - in the UK and Europe, the British-built hatchback Corolla is a firm favourite. The latest editions still sell strongly and pick up positive reviews, so there's seemingly no slowing down the Corolla's success any time soon.

Thermostat
ADD69203



Water Pump
ADT39123/31



Ball Joint
ADT38612



Stabiliser Link
ADT38501/05



Tie Rod End
ADT38701



Gas Spring
ADT35813



Washer Pump
ADT30301/02/08/11



Clutch Kit
ADT33025



Alternator
ADT311536

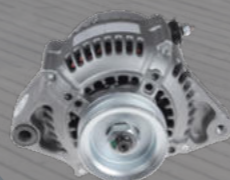

Timing Belt Kit
ADT37304

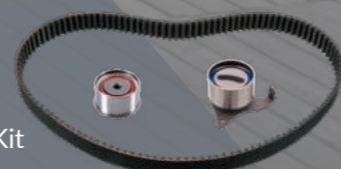

Lambda Sensor
ADBP700021/24



Ignition Coil
ADT314121



Strut Mounting
ADBP800005/ADT380220



Axle Beam Mount
ADBP800077



Engine Mounting
ADBP800230/ADT380381



Brake Disc
ADBP430132

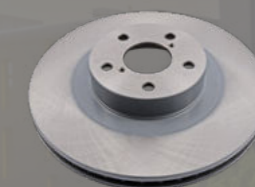

Brake Pad Set
ADT342219



Air Filter
ADT322131

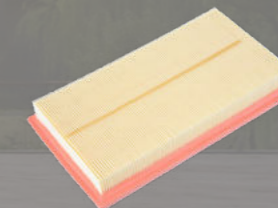

Oil Filter
ADT32109



Wheel Bearing Kit
ADBP820011



Blue Print has over 1000 parts in range for the Toyota Corolla; presented above is a selection of these parts for the Toyota Corolla VI / VIII / X / XII

bilsteingroup
partsfinder



Scan the QR code or click the link to see the full range of parts available for the Toyota Corolla on partsfinder.bilsteingroup.com



 blue-print.com

 facebook.com/blueprintpartsUK

 www.blue-print.com/youtube

Right First Time[®]

www.blue-print.com

bilsteingroup[®]