



JOURNAL  
**AGRO**



## **NÁHRADNÉ DIELY PRE POĽNOHOSPODÁRSKE A STAVEBNÉ STROJE**

ŠIROKÁ PONUKA NÁHRADNÝCH  
DIELOV PRE AGRO A PRACOVNÉ  
STROJE

---

PREDSTAVUJEME  
DODÁVATEĽOV  
NÁHRADNÝCH DIELOV

---

PONUKA GARÁŽOVÉHO  
VYBAVENIA PRE VAŠU  
DIELŇU

---

# PROMOTIVE HEAVY DUTY: MINIMALIZUJTE PRESTOJE



**VARTA® ProMotive Heavy Duty** je určená pre úžitkové a poľnohospodárske vozidlá s požiadavkami na spoľahlivý štartovací výkon. Ide o kvalitu OE a pomáha vášmu vozovému parku spoľahlivo vykonávať svoju prácu a zároveň minimalizovať prestoje.



MADE  
IN  
GERMANY

## Kľúčové výhody ProMotive Heavy Duty

- ▶ Skonstruované v Nemecku
- ▶ Patentovaná mriežka PowerFrame® pre spoľahlivý štartovací výkon, rýchle dobíjanie a odolnosť proti korózii
- ▶ Spĺňa všetky kritériá výrobcov úžitkových vozidiel ako originálny náhradný diel



[varta-automotive.com](http://varta-automotive.com)

Istý štart, to je akumulátor



CLARIOS

# OBSAH

02	INZERCIA VARTA	48	MOTOROVÉ DIELY
04	AGRO (COBO)	57	PNEUTRON
08	ADR SYSTEM	58	PALIVOVÝ SYSTÉM
11	DIELY PREVODOVKY ZF	62	PNEUMATICKÝ SYSTÉM
12	ANAÇ MAKINA	64	PONUKA AGRO OLEJOV REVLINE
16	CARRARO	66	SPOJKY
18	BRZDOVÝ SYSTÉM	72	OE AGCO
21	HYDRAULICKÉ SPOJKY FASTER	73	OE CUMMINS
24	RIADIACI SYSTÉM	74	OE JCB
26	FILTRÁCIA VOZIDLA	75	OE JOHN DEERE
35	FP DIESEL	76	PONUKA PNEUMATÍK
38	HATTAT AUTOMOTIVE	78	PRÍSLUŠENSTVO
40	CHLADENIE	89	VYBAVENIE DIELNÍ
43	KLIMATIZÁCIA		

V katalógu okrem dielov pre poľnohospodársku techniku nájdete aj diely orientované na stavebnú mechanizáciu.





# COBO: od nápadu po celosvetovú firmu

SPOLOČNOSŤ COBO VZNIKLA V ROKU 1949 A ODVTEDY VYVÍJA A VYRÁBA DIELY PRE NÁKLADNÉ VOZIDLÁ, POĽNOHOSPODÁRSKE VOZIDLÁ, ZEMNÉ STROJE, OSOBNÉ VOZIDLÁ A VYSOKOZDVIŽNÉ VOZÍKY. V ŠIROKEJ PONUKE DIELOV NÁJDEME RELÉ, SPÍNAČE, PREPÍNAČE, KÁBLOVÉ ZVÄZKY, OSVETLENIE, ALE AJ KOMPLETNÉ STĽPIKY RIADENIA, VOLANTY A SEDAČKY.

## 1949

Firma COBO vychádza z nápadov a vôle dvoch auto elektrikárov. Ich schopnosť vytvárať inovatívne produkty sa prejavila okamžite a táto schopnosť umožnila spoločnosti rozvíjať sa v nasledujúcich rokoch. V skutočnosti vďaka konštrukcii a výrobe moderných relé, nazývaných TLC (remote light change) a TLR/R (relé s oneskorením)

## 1960

Do platnosti vstupujú nové predpisy o cestnej premávke. Definujú prvky zadného osvetlenia všetkých pohybujúcich sa vozidiel. Spoločnosť opäť s predstihom vyvíja lampu pre nákladné vozidlá s požadovanými vlastnosťami, pričom na trhu dosiahla taký veľký úspech, že produkcia dosiahla až 1200 kusov denne.

## 1963

S nástupom výroby kompletných súprav pre poľnohospodárske a priemyselné prívesy a prvých produktov špeciálne navrhnutých pre poľnohospodárske stroje sa stratégia spoločnosti formuje. Stratégia je zameraná na štyri trhy:

- priemyselné vozíky a prívesy
- poľnohospodárske stroje
- zemné stroje
- vysokozdvížne vozíky.

## 1974

Po rokoch búrlivého rastu, bolo potrebné mať podnikovú a riadiacu štruktúru vhodnú pre nové dimenzie a budúce programy. Spoločnosť sa stala korporáciou, vstupom nových akcionárov a nového manažmentu. Stratégiou je dodávať štyrom cieľovým trhom čo najväčšiu škálu produktov.





## 1976

Založenie novej pobočky ktorá sa bude špecializovať na dizajn a výrobu sedadiel, volantov a kompletých stĺpikov riadenia. Týmto spôsobom sa začal program, ktorý umožní skupine získať obchodné a technické štruktúry, výrobné a logistické kapacity, aby mohla konkurovať na svetovom trhu

## 1990

Spoločné vytvorenie obchodnej pobočky v USA.

## 2000

Zmluva o integrácii so spoločnosťou CIAM (Reggio Emilia), špecializujúca sa na návrh, realizáciu elektrických schém, dispozičné štúdie, výber komponentov a výrobu kompletých systémov pre zemné stroje.

## 2002

Založenie dcérskej spoločnosti COBO INTERNATIONAL (IA-USA) - Pobočka organizovaná pre dizajn, výrobu a distribúciu produktov vyrobených skupinou na severoamerickom trhu. Akvizícia spoločnosti BC (Reggio Emilia) – plastové výlisky a volanty.



## 2005

Spustenie novej obchodnej kancelárie v Číne. CIEE – Cobo International East Europe Integrácia procesu navrhovania a výroby elektronických komponentov v hlavnom závode.

## 2009

Založenie dcérskej spoločnosti COBO Asia (Hong Kong). Založenie dcérskej spoločnosti COBO France (Francúzsko).

## 2015

Založenie COBO Group Office v Indii (New Delhi). Čínska dcérska spoločnosť premenovaná na COBO (Guangzhou) Co. Ltd.

Miestna montáž a testovanie elektronických a elektromechanických komponentov.

## 2008

Založenie dcérskej spoločnosti COBO Oceania (Austrália)

## 2014

Založenie dcérskej spoločnosti COBO Deutschland (Nemecko).



## COBO

COBO



**Sklo zadného svetla** univerzálne AGRO, so smerovkou, brzdovým a obrysovým svetlom

1009106COBO

COBO



**Sklo zadného svetla** univerzálne AGRO, so smerovkou, brzdovým svetlom a spiatočkou

1010069COBO

COBO



**Sklo zadného svetla** pre CASE IH, DAVID BROWN, FORD

1009459COBO

COBO



**Zadné svetlo** univerzálne AGRO, napätie 12V, so smerovkou, brzdovým a obrysovým svetlom

1009457COBO

COBO



**Zadné svetlo** univerzálne AGRO, napätie 12/24V, so smerovkou, brzdovým a obrysovým svetlom

1008636COBO

COBO



**Zadné svetlo** univerzálne AGRO, napätie 12/24V, so smerovkou, brzdovým svetlom, obrysovým svetlom a spiatočkou

1008186COBO

COBO



**Hlavný svetlomiet** napätie 12/24V, rozmer 112x112 mm, LANDINI, SAME

1014442COBO

COBO



**Hlavný svetlomiet** výška 151x220 mm, MERLO P, MANITOU

1015793COBO

COBO



**Hlavný svetlomiet** univerzálne AGRO, napätie 12/24V, na žiarovku H4

1013538COBO

COBO



**Obrysové svetlo** napätie 12V, dĺžka kábla 500 mm

1012081COBO

COBO



**Obrysové svetlo** napätie 12/24V, so smerovkou, dĺžka kábla 500 mm

1011934COBO

COBO



**Obrysové svetlo** DEUTZ, napätie 12V, so smerovkou

1010876COBO

COBO



**Smerové svetlo** kombinované svetlo obrysové svetlo a smerovka, napätie 12/24V, LANDINI, MASEY FERGUSON

1011301COBO

COBO



**Smerové svetlo** univerzálne AGRO, kombinované svetlo obrysové svetlo a smerovka, napätie 12V

1010768COBO

COBO



**Smerové svetlo** dĺžka kábla 270 mm, JOHN DEERE

1011895COBO



COBO



**Kontrolné svetlo** univerzálne kontrolné svetlo AGRO, rezerva paliva



1019720COBO

COBO



**Kontrolné svetlo** univerzálne kontrolné svetlo AGRO, teplota oleja



1019980COBO

COBO



**Kontrolné svetlo** univerzálne kontrolné svetlo AGRO, ukazateľ smeru jazdy



1019692COBO

COBO



**Spínač** univerzálny AGRO spínač, výstražné svetlá



1020598COBO

COBO



**Spínač** univerzálny AGRO spínač, zadné hmlové svetlo



1020600COBO

COBO



**Spínač** univerzálny AGRO spínač, maják



1020511COBO

COBO



**Spínač smerových svetiel** pre MASSEY FERGUSON



1021502COBO

COBO



**Multifunkčný prepínač** univerzál AGRO, obsahuje prepínač na diaľkové svetlá, smerové svetlo a klaksón



1021536COBO

COBO



**Spínač zapalovania**, 3 pin univerzál AGRO



1021416COBO

COBO



**Snímač hladiny oleja** pre FIAT AGRO, NEW HOLLAND



1029095COBO

COBO



**Spínač brzdových svetiel** pre LANDINI, MASEY FERGUSON



1026142COBO

COBO



**Spínač ručnej brzdy** pre LANDINI, MASEY FERGUSON



1026288COBO

COBO



**Spínač ručnej brzdy** pre CASE, FIAT AGRO, LANDINI



1021474COBO

COBO



**Multifunkčné relé** 4 pin, napätie 12V



1090916COBO

COBO



**Výstražné relé** 4 pin, napätie 12V



1003695COBO



# História spoločnosti ADR SYSTEM

Firma ADR SYSTEM je nadnárodná skupina v oblasti výroby náprav, systému pruženia a brzdového systému so zameraním na ťažké transportné, priemyslové, stavebné a agro stroje. Hlavným ťažiskom spoločnosti je distribúcia náprav pre ťažké stavebné a poľnohospodárske stroje a zabezpečovanie náhradných dielov pre svoje produkty. Firma pôsobí na trhu už viac ako 50 rokov a v súčasnej dobe spoločnosť vlastní výrobné závody v Taliansku, Francúzsku, Anglicku, Poľsku, Číne a Brazílii.

1954



#### Štart skvelého a úspešného príbehu

Giovanni a Antonia Radrizzani si otvorili svoju vlastnú malú sústružnícku firmu, v malej dedine Uboldo. Tam poskytovali práce pre tretie strany.

1960



#### Produktová špecializácia

Do spoločnosti vstupuje druhá generácia rodiny, Giancarlo a Flavio. Zo začiatku vyrábali disky pre kolesá, následne začali vyrábať nápravy. Najskôr pre stavebné stroje a postupne aj pre poľnohospodársky sektor.

1970



#### Výrazný rozvoj

Giovanni Radrizzani Snc zmenil svoj názov na ADR Spa, čím sa pretransformoval z malej remeselnej dielne na podnikateľský subjekt.





1980



## Obchod expanduje do Európy

Keď sa taliansky trh ukázal ako nedostatočný na to aby umožnil spoločnosti rásť podľa očakávaní, obrátili bratia Radrizzani svoju pozornosť na výrobcov poľnohospodárskych strojov pôsobiacich na rôznych trhoch v celej Európe.

1990



## Proces rozširovania po Európe

Začiatok rozširovania ADR po Európe datujeme od kúpy známej francúzskej spoločnosti COLAERT ESSIEUX vyrábajúcej nápravy a kompletne zavesenia pre poľnohospodárske a priemyselné stroje. Neskôr spoločnosť odkúpila ukrajinskú firmu TYREMART a stáva sa z nej ADR UK. Ďalšou spoločnosťou bola Poľská firma ATW, z ktorej sa po odkúpení stáva ADR POLSKA.

2000



## Nové milénium a nové trhy

Skupina ADR je pevne odhodlaná konsolidovať a rozširovať svoje podnikanie na mimoeurópske trhy otvorením nových výrobných a obchodných zariadení v Číne, Brazílii a Kanade.

2010



## Súčasnosť a upevňovanie pozície na trhu:

Akvizícia spoločnosti Geplasmetal v Španielsku demonštruje pokrok skupiny a jej silu. Posledným prírastok do skupiny je kúpa historickej francúzskej skupiny SAE – SMB.



## ADR SYSTEM DIELY



**Kryt náboja kola** pre nápravu ADR NA, 8 hranná, priemer 90 mm, výška 43 mm



**9RT90**



**Kryt náboja kola** pre nápravu ADR QI, 8 hranná, priemer 100 mm, výška 50 mm



**9RT100**



**Kryt náboja kola** pre nápravu ADR RM, pripevnenie skrutkami, priemer 110 mm, výška 53 mm



**9RT110AC**

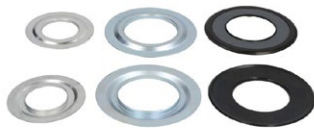

**Opravná sada náboja kola** pre nápravu ADR JA, rozmer 85/45 mm



**9RNJA**

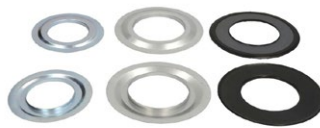

**Opravná sada náboja kola** pre nápravu ADR LA, rozmer 100/55 mm



**9RNLA**



**Opravná sada náboja kola** pre nápravu ADR UA, rozmer 140/92 mm



**9RNUA**



**Sada na opravu čapu nápravy** opravná sada zvislého čapu pre nápravy ADR, dĺžka čapu 314 mm, priemer 60/55 mm



**9RST06**



**Sada skrutiek kola** sada 12ks skrutiek pre nápravy ADR, závit M18x1.5 mm, dĺžka 54 mm



**9RC18-12**



**Sada matice kola** sada 12ks podložiek plus matíc kola pre nápravy ADR, závit M18x1.5 mm



**9RD188G-12**



**Brzdový valček bubnovej brzdy** slúži na uzamknutie vlečnej nápravy pri cúvaní, určený pre nápravy ADR IX, IV, pre brzdú 300x90 mm, priemer piestu 37 mm, celková dĺžka 100 mm



**9RE0054**



**Brzdové obloženie bubnovej brzdy** sada na 1 koleso, pre nápravu ADR VC, s nitmi a pružinami, rozmer 406x120 mm



**9RH0034**

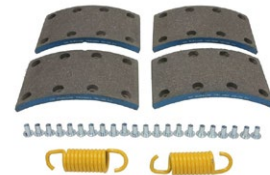

**Brzdové obloženie bubnovej brzdy** sada na 1 koleso, pre nápravu ADR VA, s nitmi a pružinami, rozmer 406x120 mm



**9RH0010**



**Brzdové čeluste** pre nápravu ADR TG, rozmer 400x80 mm



**9RE0048**



**Brzdové čeluste** pre nápravu ADR JB, rozmer 300x100 mm



**9RE0022**



**Brzdové čeluste** pre nápravu ADR IA, rozmer 300x90 mm



**9RE0012**



# Diely prevodovky ZF



Prevodovka je dôležitou súčasťou hnacieho systému, ktorý je umiestnený za spojkou. Potreba použitia ozubených kolies umiestnených v skrini prevodovky vyplýva predovšetkým z nedokonalostí spalovacieho motora, ktorý dosahuje optimálne prevádzkové parametre (vysoký výkon a vysoký krútiaci moment s možnou nízkou spotrebou paliva) pri presne definovaných rozsahoch otáčok. Prevodovka umožňuje aj trvalé odpojenie pohonu (tzv. neutrál) a zmenu smeru jazdy (spiatka). Správne používanie prevodovky je kľúčové pre životnosť akéhokoľvek vozidla, nielen traktora či iného poľnohospodárskeho stroja.



**Tesnenie prevodovky** vonkajší priemer 34.0 mm, výška 2.5 mm



0634313350ZF



**Tesnenie prevodovky** vnútorný priemer 86.0 mm, vonkajší priemer 94.0 mm, hrúbka 4.5 mm, výrobca prevodovky ZF, typ prevodovky T 7200, T 7300



0501312243ZF

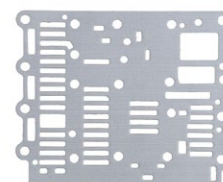

**Tesnenie prevodovky** typ prevodovky T 7300, T 7224 L



2094352040ZF



**Tlaková pružina** typ prevodovky T 7200



0732042464ZF



**Ložisko** vnútorný priemer 38.0 mm, vonkajší priemer 43.0 mm, hrúbka 17.0 mm, typ prevodovky T 7200



0735321720ZF



**Olejový filter** hydraulický filter prevodovky, DEUTZ



0501330438ZF



**Snímač otáčok** typ prevodovky ECCOM 1,8



0501221775ZF



**Riadiaci ventil** typ prevodovky T 7300 ; T 7336 L



0750132124ZF



**Ozubené koleso** typ kolesa jednoduché, počet zubov 66.0



2093310038ZF



# ANAÇ MAKINA

DO PONUKY SME PRIDALI SÚČIASTKY TURECKÉHO VÝROBCU  
PRE STAVEBNÉ STROJE ZNAČKY JCB



Spoločnosť ANAC MAKINA bola založená v roku 1990 v Istanbule ako technický servis stavebných strojov a dodávateľ náhradných dielov. Spoločnosť po niekoľkých rokoch zmenila štruktúru podnikania a zamerala sa iba na predaj a dodávku náhradných dielov pre stavebné stroje JCB.

V dnešných časoch už spoločnosť vlastní veľké sklady odkiaľ poskytuje náhradné diely domácemu trhu v Turecku a takisto ďalej distribuuje do ďalších 46 krajín po celom svete. ANAC MAKINA sa pravidelne predstavuje na medzinárodných veľtrhoch v oblasti náhradných dielov do stavebných strojov kde sa ich profesionálny tím stretáva so svojimi zákazníkmi a taktiež každoročne spoločnosť získava stále nových a nových zákazníkov.

### Ako sa ANAC MAKINA stále drží na popredných priečkach na trhu?

S našim odborným tímom a našimi dlhoročnými skúsenosťami na trhu prispôbujeme našu prácu potrebám a očakávaniam trhu. Toto poskytuje našej spoločnosti jedinečnú dynamiku a robí z nej odbornú, inovatívnu a silnú spoločnosť v oblasti obchodu s alternatívnymi náhradnými dielmi.

### Aký je náš hlavný cieľ na trhu?

Hlavným cieľom našej spoločnosti v sektore alternatívnych náhradných dielov je byť schopný uspokojiť všetky potreby trhu. S našim širokým sortimentom a kvalitou, chceme budovať budúcnosť na pevných základoch získaných v minulosti a hlavne byť rešpektovanou spoločnosťou orientovanou na rast, ktorá neustále zlepšuje svoje produkty.

### Čo vám môže ANAC MAKINA ponúknuť?

- Kvalitu produktov porovnateľná s OEM
- Konkurencieschopné ceny
- Rýchle dodanie
- Dobrá skladové zásoby
- Profesionálny servis pre zákazníka





**Koncový tmič výfuku** pre JCB 3CX, 4CX s motorom PERINS RE, RG



331-35702-AN



**Skrutka kolesa** závit 3/4 UNF, dĺžka 64,5mm



826-00923-AN



**Volant** pre JCB 3CX, 4CX



333-D1381-AN



**Objímka kardanového križa** pre JCB 3CX, 4CX



116-00525-AN



**Tesnenie** tesnenie palivového filtra JCB 3CX, 4CX



32-904708-AN



**Uzatváracia zátka olejovej vane** závit 3/4-14PTF



826-00425-AN



**Relé pracovného prúdu**



716-30148-AN



**Palivový filter** kompletný palivový filter pre JCB 3CX, 4CX s motorom DieselMax



32-925914-AN



**Kryt prednej smerovky** pre JCB 3CX, 4CX



700-38401-AN



**Kryt zadného svetla** pre JCB 3CX, 4CX, 1997 - 2001



700-37001-AN



**Spínač riadenia** smeru jazdy a klaksón



701-21201-AN



**Uzáver vyrovnácej nádržky** pre JCB 3CX, 4CX



123-06578-AN



**Uzáver plniaceho otvoru oleja** pre JCB 3CX, 4CX



02-201343-AN



**Tesnenie prevodovky** tesnenie ventilového bloku prevodovky pre JCB 3CX, 4CX



813-10175-AN



**Hadica chladenia** koleno chladiča dolné, JCB 3CX, 4CX



834-00666-AN



## ANAÇ MAKINA



**Radiaca páka** násadka radiacej páky 1 tlačidlová, JCB 3CX, 4CX



128-G6889-AN



**Plynová vzpera** zadného okna, rozmer 430x150 mm



123-05404-AN



**Plynová vzpera** tlmič dverí na starší typ kabíny, rozmer 340x110 mm



123-05403-AN



**Tesnenie motora** tesnenie veka ventilov, na motor DieselMax



320-07580-AN



**Palivový filter** sklíčko hrubého čističa paliva pre filter 32/925950



32-925708-AN



**Nádržka brzdovej kvapaliny** pre JCB 2CX, 3CX, 4CX



126-00200-AN



**Manžeta páky** starší typ, JCB 3CX, 4CX



123-10327-AN



**Termostat chladenia** pre JCB 3CX, 4CX, motor DieselMax, 2005 - 2012



320-04618-AN



**Zámok** prednej kapoty pre JCB 3CX, 4CX



333-C3140-AN



**Snímač motora** snímač tlaku motorového oleja, motor Perkins



701-80225-AN



**Snímač motora** snímač teploty vody pre motory typ AA, AB, AR, AK



716-24200-AN



**Vyrovnávacia nádržka** pre motor DieselMax



128-15480-AN



**Tlačidlový vypínač** svetiel



701-58827-AN



**Tlačidlový vypínač** prepínač maják



701-58825-AN



**Tlačidlový vypínač** prepínač pohon



701-58702-AN



Kardanový kríž rozmer 82x30.2 mm



914-80207-AN



Čerpadlo ostrekovača pre JCB 3CX, 4CX



714-20600-AN



Žhaviaca sviečka pre JCB 2CX, 3CX, 4CX



717-00100-AN



Zadné svetlo pravé, pre teleskopické manipulátory



700-50129-AN



Zámok dverí, ľavá strana pre JCB 4CX, 1997 - 2001



123-07383-AN



Nástupný schodík spodný pravý, rozmer 410 mm



331-27034-AN

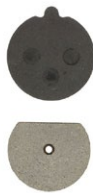

Sada brzdových platničiek na ručnú brzdú, pre JCB 3CX, 4CX, 2001-



15-920103-AN

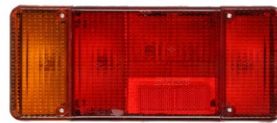

Zadné svetlo ľavá strana



700-38200-AN



Spínač zapalovania pre JCB 3CX, 4CX



701-80184-AN



Madlo na volante pre JCB 3CX, 4CX



331-27411-AN



Palivové čerpadlo ručné palivové čerpadlo, pre motor Perkins



17-913600-AN



Palivové čerpadlo ručné palivové čerpadlo, pre motor DieselMax



320-07040-AN



Uzáver palivovej nádrže priemer závitú 64 mm, priemer hrdla 88 mm



332-F4780-AN



Zámok dverí, vnútorný, ľavá strana, kabína P21



826-11105-AN



Ukazovateľ hladiny paliva pre JCB 3CX, 4CX



704-50098-AN



# Silný hráč v segmente AGRO

CARRARO JE VEĽKÝ TALIANSKY VÝROBCA PÔSOBIACI V AGRO SEGMENTE A AKO JEDEN Z MÁLA VÝROBCOV JE SCHOPNÝ VYROBIŤ NAJMENŠÍ PREVOD ALE AJ CELÝ TRAKTOR.

Firma vznikla v roku 1932 v Taliansku a v dnešnej dobe už vyrába v siedmich výrobných závodoch po celom svete. Prvý krok k medzinárodnému pôsobeniu spravili v roku 1997 keď v Indii otvorili prvý závod mimo Talianska. Neskôr otvorili závody aj v Severnej Amerike, Južnej Amerike a v Číne.



## SEGMENTY V KTORÝCH CARRARO PÔSOBÍ:

### OZUBENÉ KOLESÁ

CARRARO je už viac ako 30 rokov popredným partnerom pri vývoji a výrobe ozubených kolies pre poľnohospodárske stroje, stavebné a manipulačné vozidlá, veterné turbíny a železničné aplikácie. Vďaka neustálemu technologickému výskumu sa držia v popredí vo výrobe mechanických komponentov, od mikroaplikácií až po výrobu ozubených kolies o priemere jeden meter.

### PREVODOVÉ SÚSTAVY

Výroba prevodových systémov je hlavnou činnosťou spoločnosti CARRARO. Navrhujú, vyrábajú a predávajú prevodové systémy, ozubené kolesa a kompletne nápravy. Mechanika sa v tejto oblasti čo raz viac integruje s elektronikou. Vďaka elektronickým riadiacim jednotkám, dokážu zabezpečiť optimalizované riadenie celého hnacieho ústrojenstva (nápravy, prevodovky, motory) s cieľom zlepšiť efektivitu a znížiť spotrebu a emisie.

### TRAKTORY

CARRARO so svojimi viac ako 100 ročnými skúsenosťami poskytujú svoje zručnosti veľkým medzinárodne uznaným výrobcam, ktorí si k nim cho-

dia pre riešenia ktoré najviac vyhovujú ich potrebám. V jednom zo svojich závodov, konkrétne v Talianskom meste Rovigo, kde sa špecializujú na výrobu traktorov, vyrábajú okrem vlastných traktorov CARRARO aj traktory pre značky ako sú John Deere, Massey Ferguson, CLASS alebo Valtra. Traktory nesúce meno CARRARO sú synonymom inovácií v oblasti poľnohospodárstva. Firma sa zameriava hlavne na špecializované modely pre ovocné sady, vinohrady a na novú hybridnú verziu s nízkym dopadom na životné prostredie.

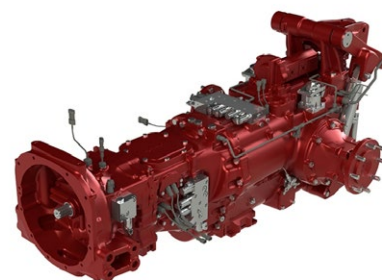





CARRARO



**Opravná sada nápravy** CARRARO, CASE, CATERPILLAR, CLAAS, KOMATSU, NEW HOLLAND, MANITOU



146260-CR

CARRARO



**Opravná sada nápravy** CARRARO, DEUTZ FAHR



68803-CR

CARRARO



**Opravná sada nápravy** CARRARO, VOLVO, TEREX, CNH



441122-CR

CARRARO



**Opravná sada diferenciálu** CARRARO, CATERPILLAR, CLAAS, DEUTZ-FAHR, KOMATSU, MANITOU, NEW HOLLAND



66156-CR

CARRARO



**Opravná sada diferenciálu** CARRARO, DEUTZ-FAHR, NEW HOLLAND, ZETOR



68756-CR

CARRARO



**Opravná sada diferenciálu** typ diferenciálu 20.11, CARRARO, CLAAS



68108-CR

CARRARO



**Diely hnacieho hriadeľa** CARRARO, CLAAS, JOHN DEERE, NEW HOLLAND, ZETOR



45253-CR

CARRARO



**Diely hnacieho hriadeľa** CARRARO, CLAAS, LANDINI, NEW HOLLAND



44155-CR

CARRARO



**Uloženie hnacieho hriadeľa** CARRARO, CLAAS, LANDINI, NEW HOLLAND



139500-CR

CARRARO



**Sada zvislých čapov** CARRARO, CLAAS, NEW HOLLAND



68874-CR

CARRARO



**Opravná sada spojky** CARRARO, JOHN DEERE, KOMATSU, MANITOU, NEW HOLLAND, VOLVO



149306-CR

CARRARO



**Filter hydrauliky** závit 13/16, vnútorný priemer 63 mm, výška 152 mm, CARRARO, CASE, KOMATSU, NEW HOLLAND, VOLVO



40701-CR

CARRARO



**Filter hydrauliky** sieťkový filter, vnútorný priemer 38 mm, výška 145 mm,



128283E-CR

CARRARO



**Snímač prevodovky** snímač teploty oleja v prevodovke, prevodovka TLB2



138645-CR

CARRARO



**Snímač prevodovky** snímač teploty oleja v prevodovke, prevodovka TLB1



373953-CR



# Brzdový systém

**SBP**  
SAFE BRAKING PRODUCTS**FTE**  
automotive

Brzdový systém je jedným z hlavných systémov automobilu a má rozhodujúci vplyv na bezpečnosť na cestách. Brzdový systém je súbor mechanizmov, ktoré umožňujú znížiť rýchlosť jazdy a zastaviť vozidlo. Brzdové mechanizmy priamo súvisia s kolesami a používajú sa na vytváranie trecieho momentu v brzdách. Konštrukcia brzdového systému má umožňovať pôsobenie na všetky kolesá vozidla s možnosťou postupného zvyšovania alebo znižovania účinnosti brzdenia pôsobením vodiča na ovládanie systému. Systém prevádzkovej brzdy by mal byť rozdelený na nezávislé okruhy tak, aby v prípade poruchy jedného z nich zvyšné okruhy zabezpečili aspoň 30% účinnosti plného pracovného systému.

**SBP**  
SAFE BRAKING PRODUCTS

**Brzdové platničky** výška 68 mm, šírka 98 mm, FENDT, DEUTZ, JOHN DEERE



07-AG005

**SBP**  
SAFE BRAKING PRODUCTS

**Brzdové platničky** priemer 66,5 mm, hrúbka 7,65 mm / 9,65 mm, JCB



07-AG015

**SBP**  
SAFE BRAKING PRODUCTS

**Brzdové platničky** výška 70 mm, šírka 90 mm, hrúbka 15 mm, ZETOR



07-AG001

**SBP**  
SAFE BRAKING PRODUCTS

**Brzdové platničky** šírka 277,5 mm, výška 103,3 mm, hrúbka 26,0 mm, VOLVO AGRO



07-AG019

**SBP**  
SAFE BRAKING PRODUCTS

**Brzdové platničky** šírka 154,0 mm, výška 89,5 mm, hrúbka 17,8 mm, DEUTZ



07-AG021

**SBP**  
SAFE BRAKING PRODUCTS

**Brzdové platničky** výška 108,0 mm, hrúbka 25,0 mm, CATERPILLAR



07-AG012

**SBP**  
SAFE BRAKING PRODUCTS

**Brzdový kotúč** vonkajší priemer 305,8 mm, počet zubov 14, JOHN DEERE



02-AG003

**SBP**  
SAFE BRAKING PRODUCTS

**Brzdový kotúč** vonkajší priemer 220,0 mm, počet zubov 27, MASSEY FERGUSON



02-AG002

**SBP**  
SAFE BRAKING PRODUCTS

**Brzdový kotúč** vonkajší priemer 313,0 mm, počet zubov 14, JOHN DEERE



02-AG005



**SBP**  
SAFE BRAKING PRODUCTS



**Brzdový kotúč** vonkajší priemer 346,5 mm, počet zubov 3, JOHN DEERE



02-AG014

**SBP**  
SAFE BRAKING PRODUCTS



**Brzdový kotúč** vonkajší priemer 309,0 mm, hrúbka 6 mm, JOHN DEERE



12-AG022

**SBP**  
SAFE BRAKING PRODUCTS



**Brzdový kotúč** pre JOHN DEERE



02-AG025

**SBP**  
SAFE BRAKING PRODUCTS



**Brzdový strmeň** vonkajší priemer 225,0 mm, FORD AGRO



TEQ-AG.003

**SBP**  
SAFE BRAKING PRODUCTS



**Brzdový strmeň** vonkajší priemer 177,8 mm, MASSEY FERGUSON



TEQ-AG.001

**SBP**  
SAFE BRAKING PRODUCTS



**Brzdový strmeň** vonkajší priemer 220,0 mm, MASSEY FERGUSON



TEQ-AG.004

**SBP**  
SAFE BRAKING PRODUCTS



**Brzdový bubon** vnútorný priemer 250,0 mm, počet zubov 23, DEUTZ



01-AG001

**SBP**  
SAFE BRAKING PRODUCTS



**Brzdový bubon** vnútorný priemer 180,0 mm, DEUTZ



01-AG002

**SBP**  
SAFE BRAKING PRODUCTS



**Brzdový bubon** vnútorný priemer 180,0 mm, DEUTZ



01-AG007

**SBP**  
SAFE BRAKING PRODUCTS



**Hlavný brzdový valec** priemer 15,87 mm, MASSEY FERGUSON



14-AG001

**SBP**  
SAFE BRAKING PRODUCTS



**Hlavný brzdový valec** pre JCB 3CX, 4CX



14-CA002

**SBP**  
SAFE BRAKING PRODUCTS



**Hlavný brzdový valec** pre CASE IH



14-CA003

**SBP**  
SAFE BRAKING PRODUCTS



**Brzdový valček** pre FORD AGRO, NEW HOLLAND



14-AG007

**SBP**  
SAFE BRAKING PRODUCTS



**Brzdový valček** pre MASSEY FERGUSON



14-AG003

**SBP**  
SAFE BRAKING PRODUCTS



**Opravná sada brzdového valčeka** pre MASSEY FERGUSON



12-AG011



## BRZDOVÝ SYSTÉM

FTE  
AUTOMOTIVE



**Brzdový valček** priemer piesta 22,2 mm,  
JUNGHEINRICH, STEINBOCK



VAL9710050

FTE  
AUTOMOTIVE



**Brzdový valček** priemer piesta 22,2 mm,  
CASE, FENDT, STEYR



VAL9710040

FTE  
AUTOMOTIVE



**Brzdový valček** priemer piesta 28,6 mm,  
CASE, LINDNER, STEYR



VAL9710089

FTE  
AUTOMOTIVE



**Brzdový valček** priemer piesta 31,8 mm,  
FENDT



VAL9710114

FTE  
AUTOMOTIVE



**Brzdový valček** priemer piesta 38,1 mm,  
KRAMER



VAL9710128

FTE  
AUTOMOTIVE



**Brzdový valček** priemer piesta 34,9 mm,  
STEYR, VALTRA



VAL9710213

FTE  
AUTOMOTIVE



**Hlavný brzdový valec** priemer piesta  
25,4 mm, FENDT



VAL9722081

FTE  
AUTOMOTIVE



**Hlavný brzdový valec** priemer piesta  
31,8 mm, ATLAS



VAL9722007

FTE  
AUTOMOTIVE



**Hlavný brzdový valec** priemer piesta  
25,4 mm, DEUTZ



VAL9722132

FTE  
AUTOMOTIVE



**Opravná sada hl. brzdového valca** priemer  
piesta 20,6 mm, FENDT



VAL9883025

FTE  
AUTOMOTIVE



**Opravná sada hl. brzdového valca** priemer  
piesta 22,2 mm, DEUTZ



VAL9883031

FTE  
AUTOMOTIVE



**Opravná sada hl. brzdového valca** priemer  
piesta 38,1 mm, CASE



VAL9883077

FTE  
AUTOMOTIVE



**Nádobka na brzdovú kvapalinu** objem  
0,15 L, výška 119,0 mm, CLASS, DEUTZ



VAL9201801

FTE  
AUTOMOTIVE



**Nádobka na brzdovú kvapalinu** objem  
0,15 L, výška 119,0 mm, FENDT



VAL9201826

FTE  
AUTOMOTIVE



**Nádobka na brzdovú kvapalinu** objem  
0,13 L, výška 90,0 mm, CASE



VAL9201824



# Hydraulické spojky FASTER

**FASTER**  
*easier to connect.*



**FASTER** je spoľahlivý partner, ktorý zaručuje špičkový výkon a riešenia na mieru. Firma **FASTER** pôsobí na medzinárodnom trhu kde si udržuje svoju vedúcu pozíciu vďaka dôležitým investíciám do výskumu a vývoja výrobných strojov a testovacích staníc. **FASTER** vyvíja všetky svoje nové produkty v úzkom vzťahu so svojimi zákazníkmi.

Vďaka dlhoročnému získavaniu skúseností sa spoločnosť **FASTER** stala synonymom rýchlospojok pre všetky hydraulické systémy.

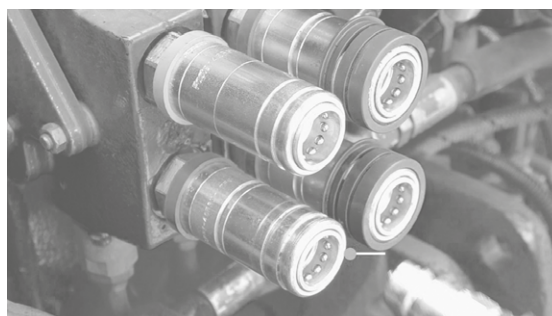



## HYDRAULICKÉ SPOJKY FASTER

Faster



**Protiprachová krytka** farba modrá, veľkosť 1/2"



TF12

Faster



**Protiprachová krytka** farba oranžová, veľkosť 1/2"



TF12A

Faster



**Protiprachová krytka** farba žltá, veľkosť 1/2"



TF12G

Faster



**Protiprachová krytka** farba žltá (automatická zástrčka), veľkosť 1/2"



TA12G

Faster



**Protiprachová krytka** farba červená (automatická zástrčka), veľkosť 1/2"



TA12R

Faster



**Protiprachová krytka** farba zelená (automatická zástrčka), veľkosť 1/2"



TA12V

Faster



**Protiprachová krytka** materiál hliník, veľkosť 3/8"



TMV38S

Faster



**Protiprachová krytka** materiál hliník, veľkosť 1/2"



TFV12S

Faster



**Protiprachová krytka** materiál hliník, veľkosť 1"



TFCVEIS

Faster



**Sada tesnení** sada na 10 hydraulických spojok, veľkosť spojky 1/4"



SK CVV 04

Faster



**Sada tesnení** sada na 10 hydraulických spojok, veľkosť spojky 3/8"



SK CVV 06

Faster



**Sada tesnení** sada na 10 hydraulických spojok, veľkosť spojky 1/2"



SK CVV 08 V

Faster



**Sada tesnení** sada na 10 hydraulických spojok, veľkosť spojky 3/4"



SK CVV 12 V

Faster

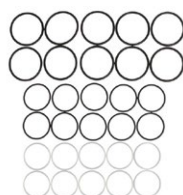

**Sada tesnení** sada na 10 hydraulických spojok, veľkosť spojky 1"



SK CVV 16 V

Faster

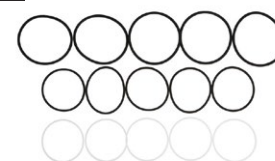

**Sada tesnení** sada na 5 hydraulických spojok, veľkosť spojky 1 1/2"



SK CVV 24 V



Faster



**Hydraulická multispojka** dve prípojky, veľkosť 3/8", maximálny prietok 40 l/min



**2PB06238GMC**

Faster



**Hydraulická multispojka** štyri prípojky, veľkosť 3/8", maximálny prietok 40 l/min



**2P506-4-12G M C**

Faster



**Hydraulická multispojka** osem prípojok, veľkosť 1/2", maximálny prietok 70 l/min



**2P808-8-12G FC**

Faster



**Nádržka na olej**, s upevnením



**TARV12BSCA3**

Faster



**Nádržka na olej**



**TAR 12 B**

Faster



**Hydraulická rýchlospojka** veľkosť pripojenie 1/2", závit M18x1,5 mm



**CNV087/1815M**

Faster



**Hydraulická rýchlospojka** veľkosť pripojenie 1/2", závit 3/4"



**FFH08 12SAE M**

Faster



**Hydraulická rýchlospojka** veľkosť pripojenie 1/2", typ NPTF



**3CFHF08 12NPT F**

Faster



**Hydraulická rýchlospojka** vonkajší závit M22x1,5 mm



**3CFHF1/2215F B**

Faster



**Hydraulická rýchlospojka** vnútorný závit 1/2"



**KIT 5DCPVA08 A**

Faster



**Hydraulická rýchlospojka** veľkosť pripojenie 1/2", závit M18x1,5 mm



**CVV082/1815MV**

Faster



**Hydraulická rýchlospojka** veľkosť pripojenie 1/2", závit M24x1,5 mm



**CVV086/2415MV**

Faster



**Hydraulická rýchlospojka** veľkosť pripojenie 1/2", závit 3/4"



**FFH08 12SAE F**

Faster



**Hydraulická rýchlospojka** veľkosť pripojenie 1/2", závit M22x1,5 mm



**3CFHF0819/2215F**

Faster



**Hydraulická rýchlospojka** vonkajší závit M22x1,5 mm



**4SRHF081/22FVAC**



# Riadiaci systém

Riadiaci systém je jedným zo základných systémov vo vozidle. Je zodpovedný za ovládanie vozidla. Hlavnou úlohou riadiaceho systému je preniesť krútiaci moment z volantu na otáčanie kolies vozidla. Základný systém riadenia zahŕňa: volant, stípiak riadenia, spojovacie tyče a čapy spojovacích tyčí. Väčšina vozidiel je vybavená posilňovačom riadenia. Moderné poľnohospodárske traktory využívajú inteligentné riadiace systémy spolupracujúce so satelitnými navigačnými systémami, ktoré uľahčujú vykonávanie úloh ako oranie alebo siatie.



**Spojovacia tyč riadenia** dĺžka 1173.0 mm,  
URSUS, MASSEY FERGUSON



STR-10A109



**Spojovacia tyč riadenia** dĺžka 855.0 mm,  
CASE



STR-20A702



**Spojovacia tyč riadenia** dĺžka 398.0 mm,  
JOHN DEERE



STR-10A076



**Spojovacia tyč riadenia** dĺžka 1220.0 mm,  
CASE



STR-10A007



**Spojovacia tyč riadenia** dĺžka 1375.0 mm,  
NEW HOLLAND



STR-10A118



**Spojovacia tyč riadenia** dĺžka 1175.0 mm,  
MASSEY FERGUSON



STR-10A108



**Spojovacia tyč riadenia** dĺžka 285.0 mm,  
veľkosť kužela 23.5 mm, JOHN DEERE



STR-11A040



**Spojovacia tyč riadenia** dĺžka 513.0 mm,  
veľkosť kužela 27.1 mm, CATERPILLAR



STR-11A031



**Spojovacia tyč riadenia** dĺžka 607.0 mm,  
veľkosť kužela 28.8 mm, JCB



STR-10A053





STR



**Axiálny čap riadenia** dĺžka 177.0 mm, veľkosť závitú M18x1.5 mm, MASSEY FERGUSON



STR-11A114

STR



**Axiálny čap riadenia** dĺžka 208.0 mm, veľkosť závitú M24x1.5 mm , veľkosť závitú 2 M22x1.5 mm, CASE



STR-11A093

STR



**Axiálny čap riadenia** dĺžka 135.0 mm, veľkosť závitú M22x1.5 mm, DEUTZ



STR-11A089

STR



**Axiálny čap riadenia** dĺžka 225.0 mm, veľkosť závitú M28x1.5 mm, veľkosť závitú 2 M22x1.5 mm, JCB



STR-11A117

STR



**Axiálny čap riadenia** dĺžka 204.0 mm, veľkosť závitú M24x1.5 mm, veľkosť závitú 2 M22x1.5 mm, JOHN DEERE



STR-11A138

STR



**Axiálny čap riadenia** dĺžka 224.0 mm, veľkosť závitú M26x1.5 mm, veľkosť závitú 2 M24x1.5 mm, FENDT



STR-11A092

STR



**Čap spojovacej tyče** dĺžka 92.0 mm, veľkosť závitú M20x1 mm, FIAT AGRO



STR-20A205

STR



**Čap spojovacej tyče** dĺžka 100.0 mm, veľkosť závitú M20x1.5 mm, VALMET



STR-20A399

STR



**Čap spojovacej tyče** dĺžka 92.0 mm, veľkosť závitú M18x1.5 mm, FENDT



STR-20A198

STR



**Čap spojovacej tyče** dĺžka 170.0 mm, veľkosť závitú M18x1.5 mm, CASE, NEW HOLLAND



STR-20A509

STR



**Čap spojovacej tyče** dĺžka 100.0 mm, veľkosť závitú M22x1.5 mm, JOHN DEERE



STR-20A283

STR



**Čap spojovacej tyče** dĺžka 120.0 mm, veľkosť závitú M24x1.5 mm, FENDT



STR-20A392

STR



**Čap spojovacej tyče** dĺžka 322.0 mm, veľkosť závitú M18x1.5 mm, JOHN DEERE



STR-20A671

STR



**Čap spojovacej tyče** dĺžka 352.0 mm, veľkosť závitú M12x1.25 mm, CASE



STR-20A018

STR



**Čap spojovacej tyče** dĺžka 500.0 mm, veľkosť závitú v palcoch 1 1/8", FORD AGRO



STR-20A781



# Filtrácia vozidla

Vo vozidlách je niekoľko typov filtrov a každý z nich plní inú úlohu. Najčastejšie sa používajú na čistenie plynov a kvapalín. Automobilové filtre sú nevyhnutnou súčasťou vozidiel, pretože filtrujú znečisťujúce látky prichádzajúce zvonku auta. Vďaka tomu sa zvyšuje životnosť kovových prvkov, a tým sa znižuje riziko častých porúch. Hlavnou úlohou filtrov je odstraňovať nečistoty a vodu, čo zabraňuje korózii kovových prvkov. Preto je použitie filtrov nevyhnutné na zabezpečenie čo najlepšej ochrany systémov vozidla. Ak sa chceme vyhnúť poruchám a nákladom súvisiacim s prípadnými opravami mali by sme filtre pravidelne kontrolovať a meniť.



**Palivový filter** pre BOMAG, WEBER



SK3454-SET



**Palivový filter** pre FENDT, AG CHEM, AKTIV FISCHER, ALLIS CHALMERS, ATLAS



SK3505



**Palivový filter** pre AGRALE, LIEBHERR, MERCEDES



SK3742



**Vzduchový filter** pre ATLAS, CARRARO, FIAT, HITACHI



SL1671



**Vzduchový filter** pre JOHN DEERE



SL8282



**Vzduchový filter** pre HONDA GARDEN



SL1822F



**Olejový filter** pre CASE, DAEWOO, HITACHI



SP4061



**Olejový filter** pre ATLAS, COMPAIR, HITACHI, INGERSOLL



SP5004



**Kabínový filter** pre KOMATSU



SKL46119



**Olejový filter** pre BOBCAT, GEHL, HITACHI, HOLDER, JOHN DEERE



**P502051**



**Olejový filter** pre FURUKAWA, HITACHI



**P550379**



**Olejový filter** pre FENDT, URSUS, ALLIS CHALMERS, AMMANN, BOBCAT, BOMAG, CASE



**P558616**

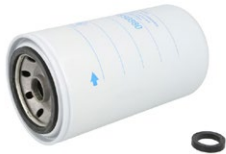

**Palivový filter** pre NEW HOLLAND



**P550880**



**Palivový filter** pre JOHN DEERE



**P551423**



**Palivový filter** pre AG CHEM, AGCO, AMMANN CASE, CHAMPION



**P551864**



**Vzduchový filter** pre BELL, CLAAS, DITCH WITCH, EXACT, HITACHI



**P611190**



**Vzduchový filter** pre ATLAS XAHS, CATERPILLAR



**P635904**



**Vzduchový filter** pre HITACHI, HYUNDAI



**DBA5293**



**Kabínový filter** pre JCB



**P955630**



**Kabínový filter** pre FENDT FARMER, NEW HOLLAND



**P783687**



**Kabínový filter** pre VOLVO



**P753389**



**Hydraulický filter** pre JCB, MANITOU



**P171540**



**Hydraulický filter** pre LIEBHERR



**P173489**



**Hydraulický filter** pre FENDT, AGCO, AHLMANN, AKTIV FISCHER, ALLIS



**P164375**

# Kvalitné filtre od značky MANN FILTER

PRI VÝBERE FILTROV SA SPOĽAHNITE NA ŽLTOZELENÚ FARBU

Filtre pre poľnohospodárske stroje sú v prevádzke vystavené najväčšiemu zaťaženiu – najmä v období zberu úrody. Veľké množstvo prachu a organických častíc, ale aj enormná mechanická záťaž, to sú nástrahy ktorým musia filtre behom ochrany vášho stroja čeliť. Filtre MANN-FILTER sú pre Vás tou najlepšou voľbou, ktorá Vám zaistí optimálnu ochranu a dlhodobú životnosť vášho stroja a 100% kvalitu odpovedajúcu originálnemu dielu.

## Kvalita sa oplatí

Vďaka mnohoročným skúsenostiam z vývoja a výroby účinných filtračných riešení nám dôverujú poprední výrobcovia poľnohospodárskych strojov. Aj vy sa tak môžete spoľahnúť na filtre značky MANN-FILTER, ktoré dlhodobo ochránia váš stroj a investície.

## Kvalita ako pri originálnych dieloch

Ako líder v odbore filtrácie ponúkame najvyššiu kvalitu ako u originálnych výrobkov, tak aj na trhu s náhradnými dielmi. Filtre značky MANN-FILTER dosahujú vždy 100% kvalitu originálnych dielov

## Vždy ten správny filter

Či hľadáte vzduchové, olejové, hydraulické alebo palivové filtre pre bezpečný chod vášho stroja, prípadne kabínové filtre pre bezpečie a komfortnú obsluhu, náš široký sortiment filtrov MANN-FILTER ponúka filtre pre všetky značky poľnohospodárskych strojov.

## Dokonalá podpora

Poskytujeme dokonalú podporu, poradenstvo a osobný prístup ku zákazníkovi. Prostredníctvom online katalógu, prípadne tlačенých katalógov ponúkame vždy ten správny filter pre váš stroj.

## MANN FILTER - výhody pre vás

- 100% kvalita originálnych dielov
- Najväčšie pokrytie trhu v Európe
- Bezpečnosť a spoľahlivosť aj v tých najnáročnejších podmienkach
- Zákaznícka podpora
- Líder na trhu v oblasti filtrácie a viac ako 65 rokov skúseností v oblasti vývoja a výroby





MANN  
FILTER



Olejový filter pre CATERPILLAR, CLAAS,  
MASSEY FERGUSON



W 9071

MANN  
FILTER



Olejový filter pre DEUTZ



HU 931 X

MANN  
FILTER



Olejový filter pre MASSEY FERGUSON,  
VALTRA



W 1374/7

MANN  
FILTER



Palivový filter pre JOHN DEERE



P 4004 X

MANN  
FILTER



Palivový filter pre CASE, NEW HOLLAND



WK 1142/2 X

MANN  
FILTER



Palivový filter pre CASE, HYUNDAI



WK 11 015 X

MANN  
FILTER



Vzduchový filter pre FENDT, BELARUS



C 34 540/1

MANN  
FILTER



Vzduchový filter pre CASE, FENDT, NEW  
HOLLAND



C 21 630/4

MANN  
FILTER



Vzduchový filter pre KUBOTA



C 10 007

MANN  
FILTER



Kabínový filter pre JOHN DEERE



CU 3125

MANN  
FILTER



Kabínový filter pre MASSEY FERGUSON



CU 88 343

MANN  
FILTER



Kabínový filter pre FENDT



CU 42 100/1

MANN  
FILTER



Hydraulický filter pre FENDT, CLAAS,  
KUBOTA, MASSEY FERGUSON, NEW  
HOLLAND



WD 10 002

MANN  
FILTER



Hydraulický filter pre CASE, KOMATSU



H 13 006 X

MANN  
FILTER



Hydraulický filter pre NEW HOLLAND  
VERSATILE



H 9011 X



## FILTRÁCIA VOZIDLA

Fleetguard



Olejový filter pre FENDT



LF596

Fleetguard



Olejový filter pre AEBI, AKTIV FISCHER, BOBCAT, CARRIER, CLAAS



HF6057

Fleetguard



Olejový filter pre URSUS, AKTIV FISCHER, ALLIS CHALMERS, ARMATRAC, BASAK, BERLIET, BOBCAT



HF35467

Fleetguard



Palivový filter pre CATERPILLAR



FS20052

Fleetguard



Palivový filter pre HITACHI, KUBOTA, MASSEY FERGUSON



FF5131

Fleetguard



Palivový filter pre CASE, CLARK



FF105

Fleetguard



Vzduchový filter pre LIEBHERR



AF55845

Fleetguard



Vzduchový filter pre HYUNDAI, VOLVO



AF27917

Fleetguard



Vzduchový filter pre BOBCAT



AF26365

Fleetguard



Kabínový filter pre KOMATSU



AF55734

Fleetguard



Kabínový filter pre JOHN DEERE



AF55779

Fleetguard



Kabínový filter pre CASE



AF55766

Fleetguard



Hydraulický filter pre ALLIS CHALMERS



HF6195

Fleetguard



Hydraulický filter pre EUCLID



HF6176

Fleetguard



Hydraulický filter pre JOHN DEERE



HF6164



WIX



Olejový filter pre JOHN DEERE



51370WIX

WIX



Olejový filter pre NEW HOLLAND, SAME



93183EWIX

WIX



Olejový filter pre DEUTZ, LAMBORGHINI



51715WIX

WIX



Palivový filter pre CASE, CATERPILLAR, GEHL, HITACHI



33740WIX

WIX



Palivový filter pre MASSEY FERGUSON



3470122WIX

WIX



Palivový filter pre JOHN DEERE



33975WIX

WIX



Vzduchový filter pre RENAULT



93044EWIX

WIX



Vzduchový filter pre MASSEY FERGUSON



42805EWIX

WIX



Vzduchový filter pre CASE, CAT, KOMATSU, VOLVO, GRADALL



42330WIX

WIX



Kabínový filter pre DEUTZ



2150015WIX

WIX



Kabínový filter pre DOOSAN



2116062WIX

WIX



Kabínový filter pre JOHN DEERE



24224WIX

WIX



Hydraulický filter pre CLAAS, AXION, MASSEY FERGUSON



8175002WIX

WIX



Hydraulický filter pre KIOTI



WL10113WIX

WIX



Hydraulický filter pre JCB



8174016WIX



## FILTRÁCIA VOZIDLA



Olejový filter pre JCB



H361W



Olejový filter pre CLAAS, NEW HOLLAND



H386W

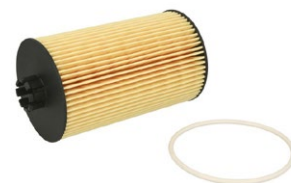

Olejový filter pre DEUTZ



E160H D28



Palivový filter pre JCB, KOMATSU



H607WK



Palivový filter pre JOHN DEERE



E486KP D452



Palivový filter pre FENDT, DEUTZ, VOLVO



E412KP02 D55



Vzduchový filter pre HITACHI, JOHN DEERE, KOMATSU, KUBOTA, SAME, NEW HOLLAND



E750L



Vzduchový filter pre CASE, KOMATSU, KUBOTA



E1496L



Vzduchový filter pre MASSEY FERGUSON



E2001LS



Kabínový filter pre KUBOTA



E5996LI



Kabínový filter pre MASSEY FERGUSON



E5958LI

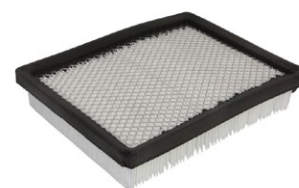

Kabínový filter pre JOHN DEERE



E5921LI



Hydraulický filter pre ASUA, BOBCAT, HITACHI



EY1007H D577



Hydraulický filter pre CATERPILLAR, JCB, YANMAR



EY1128H D664



Hydraulický filter pre CLAAS



EY876H



# The SMART Alternative.

Široká ponuka originálnych filtrov pre agro a priemyselné stroje.

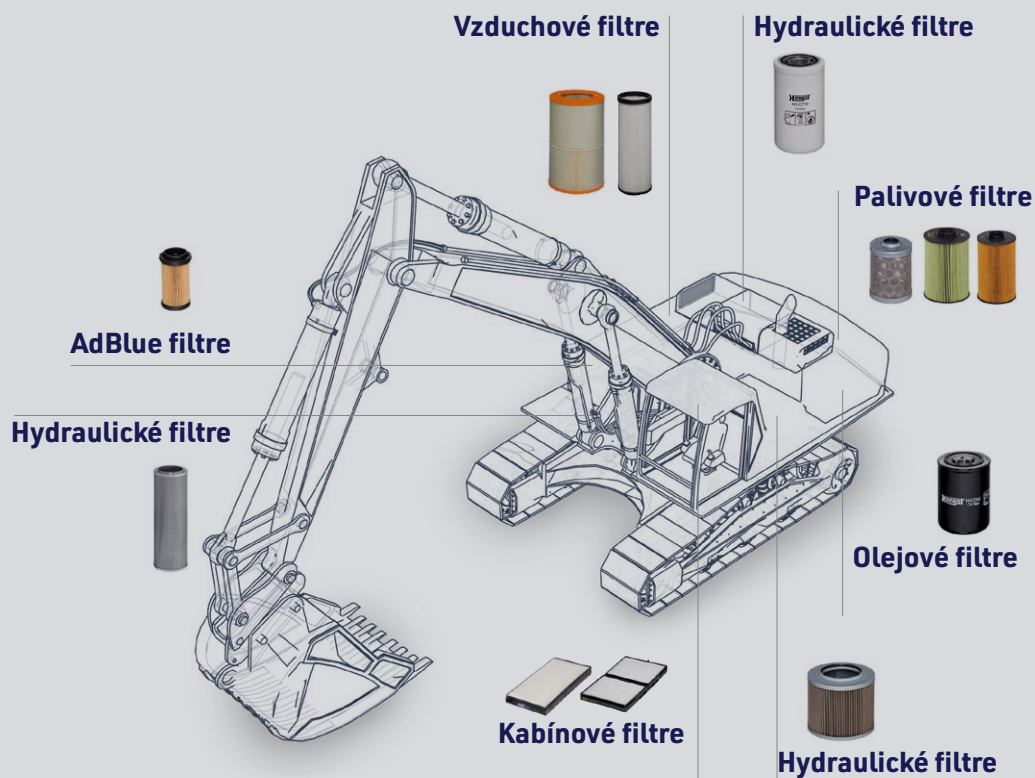



## FILTRÁCIA VOZIDLA

PURRO FILTRÁCION PRODUCT



Olejový filter pre CATERPILLAR



PUR-HO0010

PURRO FILTRÁCION PRODUCT



Olejový filter pre AG CHEM, AGCO, CASE IH, FURUKAWA, HITACHI



PUR-HO0007

PURRO FILTRÁCION PRODUCT



Olejový filter pre CASE IH, CLAAS, NEW HOLLAND



PUR-HO0036

PURRO FILTRÁCION PRODUCT



Palivový filter pre URSUS, AGCO, ARMATRAC, ATLAS, BASAK, BOBCAT, CASE



PUR-HF0058

PURRO FILTRÁCION PRODUCT



Palivový filter pre VAN HOOL



PUR-HF0038

PURRO FILTRÁCION PRODUCT



Palivový filter pre FENDT



PUR-HF0039

PURRO FILTRÁCION PRODUCT



Vzduchový filter pre AGRALE, HOLDER, KUBOTA



PUR-HA0076

PURRO FILTRÁCION PRODUCT



Vzduchový filter pre ZETOR, DEUTZ



PUR-HA0086

PURRO FILTRÁCION PRODUCT

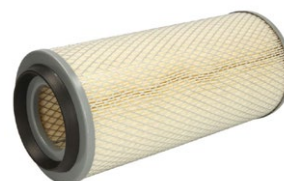

Vzduchový filter pre FENDT



PUR-HA0101

PURRO FILTRÁCION PRODUCT

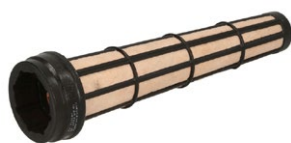

Vzduchový filter pre JCB



PUR-HA0196

PURRO FILTRÁCION PRODUCT



Vzduchový filter pre AVELING-BARFORD, BOBCAT, CASE, CLARK, GEHL



PUR-HA0051

PURRO FILTRÁCION PRODUCT



Vzduchový filter pre CASE, MAXXIMA, JCB



PUR-HA0122

PURRO FILTRÁCION PRODUCT



Kabínový filter pre KOMATSU



PUR-HC0313

PURRO FILTRÁCION PRODUCT



Kabínový filter pre JOHN DEERE



PUR-HC0016

PURRO FILTRÁCION PRODUCT



Kabínový filter pre CASE, NEW HOLLAND



PUR-HC0097



# Diely FP Diesel v našej ponuke

PRÉMIOVÁ ZNAČKA NÁHRADNÝCH DIELOV PRE ÚŽITKOVÉ VOZIDLÁ A STACIONÁRNE MOTORY V PONUKE INTER CARS

Ako súčasť skupiny FEDERAL-MOGUL je značka FP DIESEL poprednou prémiovou značkou vysokovýkonných motorových dielov a tesnení, ktorá ponúka komplexný sortiment presne skonštruovaných komponentov pre stavebníctvo, námorníctvo, poľnohospodárstvo, baníctvo a iné priemyselné odvetvia.



Komponenty FP DIESEL ponúkajú najlepšiu technológiu výroby a kvalitu náhradných dielov vysokovýkonných motorov pre palivové, vzduchové, mazacie a aj chladiace systémy. FEDERAL-MOGUL zachováva stály záväzok k neprekonateľnej kvalite produktov a k špičkovému zákazníkemu servisu. Náhradné diely FP DIESEL sú určené pre nasledujúce odvetvia:

- **Stavebníctvo**
- **Marine**
- **Poľnohospodárstvo**
- **Baníctvo**
- **Autodoprava**
- **Priemysel**



FP DIESEL ponúka svojim zákazníkom výrobky ktoré boli navrhnuté špičkovými inžiniermi a vyrobené za použitia najkvalitnejších spracovateľských metód. Preto sú naše výrobky určené do strojov ktoré pracujú v tých najťažších podmienkach a naše diely to zvládajú tisíce prevádzkových hodín. Obnovenie výkonu a zachovanie životnosti veľkoobjemového dieselového motora si vyžaduje najlepšie technológie a komponenty. Všetky komponenty sú dôkladne overené, na čo využívame našu sieť globálnych výskumných a testovacích zariadení.

FEDERAL-MOGUL ako globálny líder v oblasti systémov hnacieho ústrojenstva pre vysokovýkonné stroje zohráva kľúčovú úlohu pri vývoji každej novej generácie technológie naftových motorov. Keď si vyberiete FP DIESEL, získate jedinečné inžinierske a výrobné zdroje umiestnené do každého nášho produktu.

**DETROIT DIESEL** **CATERPILLAR** **KOMATSU** **CUMMINS** **PERKINS** **MACK** **JOHN DEERE**



## FP DIESEL



**Kompletná súprava pre generálnu opravu motora JOHN DEERE 6068**, priemer 106,5 mm



RE526966-FP



**Sada piest a vložka valca** pre motor JOHN DEERE 3029T, priemer 106,5 mm



RE500673-FP



**Sada piest a vložka valca** pre motory JOHN DEERE 4045D T, 6068 D, 6068D T, priemer 106,5 mm



RE520835-FP



**Piest** pre CATERPILLAR C6.4, GDC1-UP, priemer 104 mm



PK3244237-FP



**Piest** pre motor JOHN DEERE 3029, priemer 106,5 mm



RE500210-FP



**Piest** pre motor JOHN DEERE 4045, 6068, CLAAS 410, 420, 430, 540, priemer 106,5 mm



RE515372-FP



**Vložka valcov** pre JOHN DEERE 5500, 5055E 4WD, priemer 106,5 mm, výška 196,5 mm



R131575-FP



**Vložka valcov** pre JOHN DEERE 3010, 3020, 4010, 4020, priemer 108 mm, výška 229,1 mm



R32050WS-FP



**Vložka valcov** do motorov JOHN DEERE, výška 197 mm, priemer 106,5 mm



RE500023-FP



**Výfukový ventil** výfukový ventil pre CUMMINS L10



3803995-FP



**Sací ventil** sací ventil pre motor JOHN DEERE 4045, 6068



RE518080-FP



**Vodítko ventilu** pre CATERPILLAR C4.2, JKHT-UP, C6.4, GDC1-UP



3054885-FP



**Sada tesnení motora** kompletná sada tesnení, pre JOHN DEERE 6320, 6420, 6420S, pre motor JOHN DEERE 4045HF475



RE527010-FP

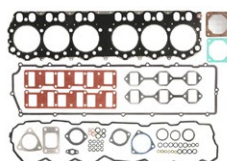

**Sada tesnení motora** vrchná sada tesnení, pre motor CATERPILLAR C6.4



3109553-FP

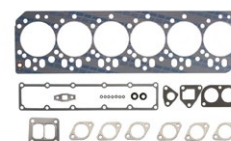

**Sada tesnení motora** vrchná sada tesnení, pre motor JOHN DEERE 6068



RE518152-FP



Sada piestnych krúžkov JOHN DEERE, štandard, priemer 108 mm



AR51741-FP



Sada piestnych krúžkov JOHN DEERE, štandard, priemer 98 mm



AR70633-FP



Sada piestnych krúžkov JOHN DEERE, štandard, priemer 106,5 mm



RE507852-FP



Ložiská kľukového hriadeľa JOHN DEERE, štandard, vnútorný priemer 79.415 mm



RE65168-FP



Ložiská kľukového hriadeľa JOHN DEERE, štandard, vnútorný priemer 85.644 mm



AR77748-FP



Ložiská kľukového hriadeľa JONH DEERE, +0.25 mm, vnútorný priemer 82 mm, vonkajší priemer 93.5 mm



AR74816-FP



Ojničné ložiská štandard, pre motor JOHN DEERE 6081 HF



R525767-FP



Ojničné ložiská štandard, JONH DEERE rada 6000 a 7000, objem motora 6.8L



RE65908-FP



Ojničné ložiská + 0.50 mm, JONH DEERE rada 6000 a 7000, objem motora 6.8L



AR97654-FP



Podložka vstrekača CATERPILLAR C2.2



1903762-FP



Tesnenie kolektoru výfukových plynov pre motor JOHN DEERE 6068 T/H/HL



R124607-FP



Púzdvo ojnice vnútorný priemer 30 mm, vonkajší priemer 34 mm, výška 40 mm



T23471-FP



Gulová panva zdvihátka ventilov CATERPILLAR C4.2, C6.4



1992187-FP



Pružina ventilu JOHN DEERE 1000 - 9000



R26125-FP



Vodné čerpadlo motora pre motor JOHN DEERE 6081



RE521503-FP



# HATTAT AUTOMOTIVE



Hattat Automotive je spoločnosť, ktorá pôsobí v obchode s náhradnými dielmi prostredníctvom svojich distribútorov po celom svete. Osobné automobily, ľahké úžitkové vozidlá, ťažké úžitkové vozidlá, poľnohospodárske traktory a priemyselné stroje, v týchto všetkých segmentoch pôsobí Hattat Automotive. Snažíme sa poskytovať produkty a služby v správny čas na cieľové trhy prostredníctvom našich obchodných partnerov a sietí, s našimi skúsenými zamestnancami v súlade s udržateľnou politikou ceny a kvality.

## História spoločnosti

- Založené pod menom Hattat Makineleri Sanayi ve Tic. A.S v roku 1982 v Maslaku / Istanbulu.
- V roku 1985 sa názov spoločnosti zmenil na Hattat Makine ve Sanayi Ticaret A.S.
- V priebehu 90. rokov boli do sortimentu pridané náhradné diely pre nákladné vozidlá.
- V roku 1994 sa kancelária spoločnosti presťahovala do zóny organizovaného priemyslu Cerkezkooy v Tekirdag.
- V roku 1996 sa názov spoločnosti zmenil na Hattat Otomotiv Pazarlama A.S.
- V roku 1999 bola založená sieť predajcov dielov pre osobné automobily a ľahké úžitkové vozidlá.
- V roku 2002 sa začal predaj liatinových čerpadiel pre priemyselné aplikácie.

**HATTAT**  
OTOMOTIV PAZARLAMA A.Ş.



## Sortiment výrobkov:



pre osobné vozidlá



pre nákladné vozidlá



pre poľnohospodárske vozidlá



Hydraulické súčiastky pre stavebné stroje



Priemyselné hydraulické súčiastky



Pneumatiky pre agro a ťažké stroje





**HATTAT**  
OTOMOTIV PAZARLAMA A.S.



**Hydraulické zubové čerpadlo DEUTZ**,  
pracovný smer ľavý, prepravovaný objem 8,2  
cm<sup>3</sup> za otáčku



1PN082AST3/432

**HATTAT**  
OTOMOTIV PAZARLAMA A.S.



**Hydraulické zubové čerpadlo EICHER**,  
GULDNER, LINDNER, pracovný smer pravý,  
prepravovaný objem 16,8 cm<sup>3</sup> za otáčku



1PN168CSS3/449

**HATTAT**  
OTOMOTIV PAZARLAMA A.S.



**Hydraulické zubové čerpadlo**  
HUERLIMANN 6130, pracovný smer ľavý,  
prepravovaný objem 16,8 cm<sup>3</sup> za otáčku



1PN168ABST1/420

**HATTAT**  
OTOMOTIV PAZARLAMA A.S.



**Hydraulické zubové čerpadlo NEW**  
HOLLAND, CASE, pracovný smer pravý,  
prepravovaný objem 19,2 cm<sup>3</sup> za otáčku



1PN.192.CB11/064

**HATTAT**  
OTOMOTIV PAZARLAMA A.S.



**Hydraulické zubové čerpadlo**  
HURLIMANN, SAME, pracovný smer ľavý,  
prepravovaný objem 22,9 cm<sup>3</sup> za otáčku



1PN229AB11/452

**HATTAT**  
OTOMOTIV PAZARLAMA A.S.



**Hydraulické zubové čerpadlo MASSEY**  
FERGUSON, pracovný smer ľavý,  
prepravovaný objem 6 cm<sup>3</sup> za otáčku



1P1.1175.A/416

**HATTAT**  
OTOMOTIV PAZARLAMA A.S.



**Hydraulické zubové čerpadlo FENDT**,  
pracovný smer ľavý, prepravovaný objem  
výstup 1 - 11,9 cm<sup>3</sup> za otáčku, výstup 2 -19,2  
cm<sup>3</sup> za otáčku



1PN/1PN/121

**HATTAT**  
OTOMOTIV PAZARLAMA A.S.



**Hydraulické zubové čerpadlo MASSEY**  
FERGUSON, pracovný smer ľavý,  
prepravovaný objem výstup 1 - 10 cm<sup>3</sup> za  
otáčku, výstup 2 - 8,2 cm<sup>3</sup> za otáčku



1PN/1PN/254

**HATTAT**  
OTOMOTIV PAZARLAMA A.S.



**Hydraulické zubové čerpadlo FORD**,  
pracovný smer ľavý, prepravovaný objem  
14,7 cm<sup>3</sup> za otáčku



1P2.147.A/288

**HATTAT**  
OTOMOTIV PAZARLAMA A.S.



**Hydraulické zubové čerpadlo DEUTZ**  
FAHR, CASE, FENDT, NEW HOLLAND,  
pracovný smer ľavý, prepravovaný objem  
výstup 1 - 11,9 cm<sup>3</sup> za otáčku, výstup 2 -16,8  
cm<sup>3</sup> za otáčku



1PN/1PN/123

**HATTAT**  
OTOMOTIV PAZARLAMA A.S.



**Hydraulické zubové čerpadlo MASSEY**  
FERGUSON, pracovný smer ľavý,  
prepravovaný objem výstup 1 - 6,1 cm<sup>3</sup> za  
otáčku, výstup 2 - 9 cm<sup>3</sup> za otáčku



0017659U91

**HATTAT**  
OTOMOTIV PAZARLAMA A.S.



**Stabilizačný mechanizmus FORD**, NEW  
HOLLAND



1PN/BAL/916

**HATTAT**  
OTOMOTIV PAZARLAMA A.S.



**Hydraulické riadenie riadenie Orbital**,  
NEW HOLLAND



HHU100ON.4

**HATTAT**  
OTOMOTIV PAZARLAMA A.S.



**Kľukový hriadel' PERKINS** 1004.4, 1004.40,  
4.236, 4.238, A4.41



1PN/CRA/996

**HATTAT**  
OTOMOTIV PAZARLAMA A.S.



**Olejové čerpadlo PERKINS**, CASE, MASSEY  
FERGUSON



1PN/BAL/062



# Chladienie vozidla

Účelom chladiaceho systému je zabrániť zvýšeniu teploty motora nad maximálnu hodnotu (do 150°C) a udržiavať ju v optimálnom rozsahu, t.j. od 90°C do 100°C. Správna funkcia chladiaceho systému je nevyhnutná, aby motor dosiahol správne prevádzkové podmienky. Pri absencii chladienia rýchlo narastá teplota základných častí motora, čo má za následok: 1) zhoršenie mazania (strata mazacích vlastností oleja a jeho spaľovanie), 2) výskyt predčasného vznietenia zmesi, 3) nadmerná tepelná rozťažnosť piestu vo valci, ktorá zvyčajne končí jeho rozbitím. Neodporúča sa ani príliš nízka prevádzková teplota. Spôsobuje to okrem iného zhoršujúce sa podmienky pre odparovanie paliva, čo narúša proces spaľovania a môže viesť k zvýšeným emisiám.



THERMOTEC



Vodná pumpa KUBOTA B, BX



WP-KU107

THERMOTEC



Vodná pumpa URSUS, LANDINI



WP-CA112

THERMOTEC

Vodná pumpa BOBCAT, MANITOU,  
KUBOTA

WP-KU108

MOTIVE  
COMPONENTS LTD

Vodná pumpa MASSEY FERGUSON



MOTWP3616

MOTIVE  
COMPONENTS LTD

Vodná pumpa CASE, NEW HOLLAND



MOTWP3549

DOLZ

Vodná pumpa FENDT, DEUTZ,  
LAMBORGHINI, SAME

DOLZ D250

DOLZ

Vodná pumpa VOLVO, MASSEY  
FERGUSON

DOLZ D301

Vodná pumpa URSUS, AHLMANN, ATLAS,  
CATERPILLAR, EICHER, FORD, HYSTER,  
LANDINI

OMP159.375



Vodná pumpa CASE, LANDINI



OMP159.490





THERMOTEC



Termostat otváracia teplota 71°C, YANMAR



D2AG017TT

THERMOTEC



Termostat otváracia teplota 79°C, CASE, NEW HOLLAND



D2CA004TT

THERMOTEC



Termostat otváracia teplota 82°C, JOHN DEERE



D2JD008TT

BorgWarner



Ventilátor chladenia priemer 570 mm, VALTRA



O20003902

cojali



Ventilátor chladenia priemer 455 mm, FENDT



8521632COJ

MAHLE



Ventilátor chladenia priemer 600 mm, JOHN DEERE



CFW 52 000P

THERMOTEC



Spojka ventilátora priemer 163 mm, JOHN DEERE



D5JD003TT

BorgWarner



Spojka ventilátora priemer 160,3 mm, CUMMINS, NEW HOLLAND



18307-1

cojali



Spojka ventilátora priemer 205 mm, JOHN DEERE



8521141COJ

VDO



Snímač teploty chladiacej kvapaliny veľkosť závitu M14, teplota 120 °C, CASE, CLAAS



A2C5218485780

VDO



Snímač teploty chladiacej kvapaliny veľkosť závitu M14, teplota 120 °C, MASSEY FERGUSON



323-805-017-002C

VDO



Snímač teploty chladiacej kvapaliny veľkosť závitu M14, teplota 120 °C, DEUTZ, FENDT



323-805-039-001C

THERMOTEC



Chladič oleja hrúbka 37 mm, šírka 120 mm, výška 250 mm, DEUTZ



D4AG021TT

HIGHWAY



Chladič oleja hrúbka 89 mm, šírka 79 mm, výška 165 mm, FENDT



30108002HW

BF ORIGINAL



Chladič oleja hrúbka 280 mm, šírka 160 mm, výška 280 mm, FENDT, DEUTZ, SAME



20 190 520 122



## CHLADENIE



**Vodný chladič** výška 301 mm, šírka 344 mm, hrúbka 36 mm, KUBOTA



**NRF 50020**



**Vodný chladič** výška 385 mm, šírka 470 mm, hrúbka 59 mm, MASSEY FERGUSON



**NRF 52145**



**Vodný chladič** výška 410 mm, šírka 450 mm, hrúbka 59 mm, NEW HOLLAND



**NRF 53659**



**Vodný chladič** výška 460 mm, šírka 539 mm, hrúbka 62 mm, CASE, NEW HOLLAND



**NRF 54069**



**Vodný chladič** výška 410 mm, šírka 460 mm, hrúbka 59 mm, LANDINI



**NRF 530003**



**Vodný chladič** výška 460 mm, šírka 539 mm, hrúbka 62 mm, CASE, NEW HOLLAND



**NRF 54089**



**Vodný chladič** výška 350 mm, šírka 418 mm, hrúbka 49 mm, KUBOTA



**NRF 55352**



**Vodný chladič** výška 390 mm, šírka 500 mm, hrúbka 71 mm, CASE



**NRF 53657**



**Vodný chladič** výška 505 mm, šírka 620 mm, hrúbka 105 mm, JCB



**NRF 52167**



**Vodný chladič** výška 480 mm, šírka 520 mm, hrúbka 76 mm, JOHN DEERE



**NRF 52243**



**Vodný chladič** výška 504 mm, šírka 576 mm, hrúbka 74 mm, JOHN DEERE



**NRF 50585**



**Vodný chladič** výška 490 mm, šírka 508 mm, hrúbka 59 mm, CASE



**NRF 52104**



**Vodný chladič** výška 526 mm, šírka 548 mm, hrúbka 100 mm, MASSEY FERGUSON



**NRF 54085**



**Vodný chladič** výška 470 mm, šírka 605 mm, hrúbka 72 mm, FENDT



**NRF 504530**



**Vodný chladič** výška 526 mm, šírka 596 mm, hrúbka 122 mm, CASE, NEW HOLLAND



**NRF 54079**



# Klimatizácia

Klimatizáciu sa oplatí mať aj vo farmárskom traktore. Väčšina ľudí musí používať poľnohospodársky traktor aj keď je vonkajšia teplota vzduchu veľmi vysoká, napríklad počas obdobia zberu. Vtedy je dôležité znížiť teplotu v kabíne. K tomu pomáha práve klimatizácia. V prvom rade by ste si mali dať pozor na to, že poľnohospodársky traktor je postavený charakteristickým spôsobom so štyrmi sklenenými stenami, ktoré nijako nechránia pred vysokou alebo nízkou teplotou vzduchu. Klimatizácia umožňuje získať tepelnú pohodu, čo výrazne zvyšuje kvalitu a efektivitu práce. Klimatizácia si však vyžaduje pravidelnú údržbu, aby bola účinná a spoľahlivo vám slúžila čo najdlhšie. Nekontrolovanie stavu jednotlivých komponentov môže viesť k vážnym poruchám a nákladným opravám.



**Kompresor klimatizácie** typ kompresoru 10PA15C, olejová náplň objem 160 ml, priemer remenice 119.6 mm, JOHN DEERE



DCP99505



**Kompresor klimatizácie** typ kompresoru 10PA15C, olejová náplň objem 170 ml, priemer remenice 119.6 mm, JOHN DEERE



DCP99513



**Kompresor klimatizácie** typ kompresoru 10PA15C, olejová náplň objem 220 ml, priemer remenice 150.0 mm, KOMATSU



DCP99827



**Kompresor klimatizácie** typ kompresoru 10PA17C, olejová náplň objem 240 ml, priemer remenice 140.0 mm, JOHN DEERE



DCP99510



**Kompresor klimatizácie** typ kompresoru 10S17C, olejová náplň objem 200 ml, priemer remenice 140.0 mm, CATERPILLAR



DCP99812



**Kompresor klimatizácie** typ kompresoru 10S15C, olejová náplň objem 200 ml, priemer remenice 120.0 mm, CLAAS



DCP23539



**Kompresor klimatizácie** Typ kompresoru SV07E, olejová náplň objem 110 ml, priemer remenice 108.0 mm, KUBOTA



DCP99830



**Kompresor klimatizácie** typ kompresoru 10S17C, olejová náplň objem 220 ml, priemer remenice 120.0 mm, DEUTZ



DCP99519



**Kompresor klimatizácie** typ kompresoru 10PA15C, olejová náplň objem 245 ml, priemer remenice 130.0 mm, CLAAS



DCP17501



## KLIMATIZÁCIA

**Tcci**



**Kompresor klimatizácie** typ kompresoru SD7H15, olejová náplň objem 135 ml, priemer remenice 132.0 mm, JCB



QP7H15-4647

**Tcci**



**Kompresor klimatizácie** typ kompresoru SD7H15, priemer remenice 132.0 mm, VALTRA



QP7H15-4664

**Tcci**



**Kompresor klimatizácie** typ kompresoru SD7H15, olejová náplň objem 200 ml, priemer remenice 132.0 mm, CLAAS, MASSEY FERGUSON



QP7H15-7851

**Tcci**



**Kompresor klimatizácie** typ kompresoru SD7H15, olejová náplň objem 150 ml, priemer remenice 134.0 mm, CASE, NEW HOLLAND



QP7H15-7929

**Tcci**



**Kompresor klimatizácie** typ kompresoru SD7H15, priemer remenice 152.0 mm, CLAAS



QP7H15-7975

**Tcci**



**Kompresor klimatizácie** typ kompresoru SD7H15, olejová náplň objem 135 ml, priemer remenice 119.0 mm, CASE, NEW HOLLAND



QP7H15-8028

**Tcci**



**Kompresor klimatizácie** typ kompresoru SD7H15, priemer remenice 148.0 mm, DEUTZ, LAMBORGHINI



QP7H15-8091

**Tcci**



**Kompresor klimatizácie** typ kompresoru SD7H15, olejová náplň objem 135 ml, priemer remenice 119.0 mm, CASE, NEW HOLLAND



QP7H15-8100

**Tcci**



**Kompresor klimatizácie** typ kompresoru SD7H15, olejová náplň objem 190 ml, priemer remenice 119.0 mm, MASSEY FERGUSON



QP7H15-8244

**Tcci**



**Kompresor klimatizácie** typ kompresoru SD7H15, olejová náplň objem 285 ml, priemer remenice 152.0 mm, CASE, NEW HOLLAND



QP7H15-4499

**Tcci**



**Kompresor klimatizácie** typ kompresoru SD7H15, olejová náplň objem 270 ml, priemer remenice 133.0 mm, FORD, NEW HOLLAND



QP7H15-4637

**Tcci**



**Kompresor klimatizácie** typ kompresoru SD5H14, olejová náplň objem 175 ml, priemer remenice 132.0 mm, CASE, NEW HOLLAND



QP5H14-4513

**Tcci**



**Kompresor klimatizácie** typ kompresoru QP16, olejová náplň objem 200 ml, priemer remenice 135.0 mm, CASE, CLAAS, VALTRA



QP16-1186

**Tcci**



**Kompresor klimatizácie** typ kompresoru QP-7H15, priemer remenice 152.0 mm, CLAAS, NEW HOLLAND



QP7H15-2036

**Tcci**



**Kompresor klimatizácie** typ kompresoru 10PA17C, olejová náplň objem 200 ml, priemer remenice 140.0 mm, JOHN DEERE



QP10PA17-2544



**Kondenzátor klimatizácie** šírka 515.0 mm, výška 405.0 mm, hrúbka 62.0 mm, JOHN DEERE



NRF 35371



**Kondenzátor klimatizácie** šírka 565.0 mm, výška 405.0 mm, hrúbka: 62.0 mm, JOHN DEERE



NRF 35370



**Vysúšač klimatizácie** výška 233.0 mm, priemer 76.0 mm, JOHN DEERE



NRF 33283



**Vysúšač klimatizácie** výška 200.0 mm, priemer 102.0 mm, CASE, JOHN DEERE, NEW HOLLAND



NRF 33209



**Vysúšač klimatizácie** výška 191.0 mm, priemer 95.0 mm, CASE, CLAAS



NRF 33219



**Vysúšač klimatizácie** výška 294.0 mm, priemer 51.0 mm, FENDT



NRF 33232



**Kompresor klimatizácie** typ kompresoru 10S15C, olejová náplň objem 180 ml, priemer remenice 152.0 mm, JOHN DEERE, CATERPILLAR



NRF 32926



**Kompresor klimatizácie** typ kompresoru 10PA17C, olejová náplň objem 230 ml, priemer remenice 140.0 mm, JOHN DEERE



NRF 32662



**Kompresor klimatizácie** typ kompresoru SD7H15, olejová náplň objem 285 ml, priemer remenice 152.0 mm, CASE, NEW HOLLAND



NRF 32877



**Kompresor klimatizácie** typ kompresoru SD7H15, olejová náplň objem 300 ml, priemer remenice 152.0 mm, CATERPILLAR



NRF 32879



**Kompresor klimatizácie** typ kompresoru SD7H15-8028, olejová náplň objem 240 ml, priemer remenice 119.0 mm, CASE, NEW HOLLAND



NRF 32142



**Kompresor klimatizácie** typ kompresoru SD7H15-8019, olejová náplň objem 240 ml, priemer remenice 132.0 mm, DEUTZ, LAMBORGHINI, MASSEY FERGUSON



NRF 32138



**Kompresor klimatizácie** typ kompresoru SD7H15, olejová náplň objem 190 ml, priemer remenice 112.0 mm, MASSEY FERGUSON



NRF 320124



**Kompresor klimatizácie** typ kompresoru SD7H15, olejová náplň objem 300 ml, priemer remenice 152.0 mm, CATERPILLAR



NRF 32885



**Kompresor klimatizácie** typ kompresoru 10PA17C, olejová náplň objem 230 ml, priemer remenice 140.0 mm, JOHN DEERE



NRF 32661



## KLIMATIZÁCIA



**Expanzný ventil klimatizácie** rozmer závitu sacej strany 15,88 mm / 15,88 mm, rozmer závitu tlačnej strany 9,53 mm / 15,88 mm, CASE, CATERPILLAR, DEUTZ



EXV-1005



**Expanzný ventil klimatizácie** rozmer závitú výstup 15 mm, rozmer závitú vstup 20 mm, AGCO, CASE, JOHN DEERE, NEW HOLLAND, MASSEY FERGUSON



EXV-1017



**Expanzný ventil klimatizácie** rozmer závitú sacej strany 15,88 mm / 19,05 mm, rozmer závitú tlačnej strany 9,53 mm / 12,7 mm, JOHN DEERE



EXV-1000



**Vysúšač klimatizácie** výška 240.0 mm, priemer 75.0 mm, AGCO, CASE, NEW HOLLAND



ARD-1057



**Vysúšač klimatizácie** výška 300.0 mm, priemer 45.0 mm, DEUTZ



ARD-1188



**Vysúšač klimatizácie** výška 175.0 mm, priemer 100.0 mm, CASE



ARD-1018



**Kompresor klimatizácie** typ kompresoru SD508, olejová náplň objem 210 ml, priemer remenice 132.0 mm, NEW HOLLAND



CO-2214CA



**Kompresor klimatizácie** typ kompresoru SD7H15, olejová náplň objem 240 ml, priemer remenice 125.0 mm, CASE, CATERPILLAR



CO-2019CA



**Kompresor klimatizácie** typ kompresoru SD7H15, olejová náplň objem 300 ml, priemer remenice 138.0 mm, CLAAS, CATERPILLAR



CO-2069CA



**Kompresor klimatizácie** typ kompresoru SD7H15, olejová náplň objem 300 ml, priemer remenice 132.0 mm, CATERPILLAR



CO-2071CA



**Kompresor klimatizácie** typ kompresoru 10S17C, olejová náplň objem 200 ml, priemer remenice 140.0 mm, CATERPILLAR



CO-1049CA



**Kompresor klimatizácie** typ kompresoru 10PA15C, olejová náplň objem 160 ml, priemer remenice 130.0 mm, JOHN DEERE



CO-1021CA



**Kompresor klimatizácie** typ kompresoru 6E171, olejová náplň objem 80 ml, priemer remenice 145.0 mm, JOHN DEERE



CO-1005CA



**Kompresor klimatizácie** typ kompresoru 10S17C, olejová náplň objem 160 ml, priemer remenice 135.0 mm, CARERPILLAR



CO-1050CA



**Kompresor klimatizácie** typ kompresoru SD510, olejová náplň objem 200 ml, priemer remenice 132.0 mm, AGCO, MASSEY FERGUSON



CO-2057CA



THERMOTEC



**Expanzný ventil klimatizácie** rozmer závitu výstup 18,0 mm, rozmer závitu vstup 20,0 mm, CASE, JOHN DEERE, NEW HOLLAND, MASSEY FERGUSON



KTT140057

THERMOTEC



**Expanzný ventil klimatizácie** rozmer závitu sanie 18,0 mm, rozmer závitu tlak 16,0 mm, AGCO, CASE, CATERPILLAR, CLAAS, JOHN DEERE



KTT140058

THERMOTEC



**Expanzný ventil klimatizácie** rozmer závitu výstup 18,0 mm, rozmer závitu vstup 20,0 mm, CASE, JOHN DEERE, NEW HOLLAND, MASSEY FERGUSON



KTT140055

THERMOTEC



**Vysúšač klimatizácie** výška 200,0 mm, priemer 76,0 mm, MASSEY FERGUSON



KTT120186

THERMOTEC



**Vysúšač klimatizácie** výška 200,0 mm, priemer 100,0 mm, CASE, NEW HOLLAND



KTT120162

THERMOTEC



**Vysúšač klimatizácie** výška 228,0 mm, priemer 76,0 mm, AGCO



KTT120163

THERMOTEC



**Vysúšač klimatizácie** výška 225,0 mm, priemer 100,0 mm, JOHN DEERE



KTT120152

THERMOTEC



**Vysúšač klimatizácie** výška 220,0 mm, priemer 74,0 mm, CLAAS, VOLVO



KTT120153

THERMOTEC



**Vysúšač klimatizácie** výška 191,0 mm, priemer 95,0 mm, CASE, CLAAS



KTT120160

THERMOTEC



**Kompresor klimatizácie** typ kompresoru SV07E, olejová náplň objem 110 ml, priemer remenice 108,0 mm, KUBOTA



KTT090238

THERMOTEC



**Kompresor klimatizácie** typ kompresoru SD7H15, olejová náplň objem 190 ml, priemer remenice 119,0 mm, MASSEY FERGUSON, AGCO



KTT090362

THERMOTEC



**Kompresor klimatizácie** typ kompresoru SD7H15, olejová náplň objem 170 ml, priemer remenice 132,0 mm, VOLVO



KTT090386

THERMOTEC



**Kompresor klimatizácie** typ kompresoru SV07E, Olejová náplň objem 110 ml, priemer remenice 108,0 mm, KUBOTA



KTT090244

THERMOTEC



**Kompresor klimatizácie** typ kompresoru 10PA15C, olejová náplň objem 220 ml, priemer remenice 119,6 mm, CLAAS



KTT090259

THERMOTEC



**Kompresor klimatizácie** typ kompresoru 10PA15C, olejová náplň objem 180 ml, priemer remenice 119,0 mm, CLAAS, DEUTZ



KTT090347



# Motorové diely

Diesellové motory sú samozápalové motory. Sú tiež klasifikované ako motory, ktoré majú piestový tlak na oveľa vyššej úrovni ako nízkotlakové motory. Diesellové motory sa vyznačujú vnútorným spaľovaním, ktoré nevyžaduje žiadny vonkajší zdroj. Celý proces spaľovania prebieha tak, že sa vzduch dostane do valca, kde sa rozpráši palivo a následne dôjde k spaľovaniu. Takéto motory si zaslúžia osobitnú pozornosť, pretože použitím danej technológie je zabezpečená nielen úplná plynulosť a komfort jazdy, ale aj výrazne nižšia spotreba paliva.



**Ojnica** dĺžka 201.0 mm, priemer 67.0 mm, priemer čapu 35.0 mm, DEUTZ FAHR



04 0310 226000



**Ojnica** dĺžka 216.0 mm, priemer 64.0 mm, priemer čapu 35.0 mm, DEUTZ FAHR



04 0310 912000



**Ojnica** dĺžka 161.0 mm, priemer 70.0 mm, priemer čapu 40.0 mm, DEUTZ FAHR



04 0310 913000



**Piest** priemer 91.0 mm, priemer čapu 26.0 mm, dĺžka čapu 86.27 mm, DEUTZ



04 0320 101100



**Piest** priemer 105.0 mm, priemer čapu 35.0 mm, dĺžka čapu 102.4 mm, DEUTZ FAHR, FENDT



04 0320 226000



**Piest** priemer 108.0 mm, priemer čapu 42.0 mm, dĺžka čapu 108.0 mm, DEUTZ FAHR, MAZ



04 0320 101300



**Vložka valcov** vnútorný priemer 102.0 mm, vonkajší priemer 104.58 mm, dĺžka 200.0 mm, CUMMINS, DAF



09 0110 B40000



**Vložka valcov** vnútorný priemer 102.0 mm, vonkajší priemer 110.0 mm, dĺžka 222.3 mm, IVECO, DEUTZ FAHR



04 0110 913001



**Vložka valcov** vnútorný priemer 114.0 mm, vonkajší priemer 125.68 mm, dĺžka: 234.12 mm, CUMMINS



09 0119 C60000





KOLBENSCHMIDT



**Ojničné ložisko** veľkosť 1.0, šírka 25.0 mm, pre hrúbku steny od 2.485 mm, priemer hriadele od 64.971 mm do 64.99 mm, FENDT, AGCO, CASE, DEUTZ FAHR



78 276 640

KOLBENSCHMIDT



**Ojničné ložisko** veľkosť 0.25, šírka 27.1 mm, pre hrúbku steny od 2.125 mm, priemer hriadele od 62.7 mm do 62.72 mm, FORD, FENDT, DEUTZ FAHR



78 588 610

KOLBENSCHMIDT



**Ojničné ložisko** veľkosť STD, šírka 31.88 mm, pre hrúbku steny od 1.842 mm, priemer hriadele od 63.47 mm do 63.495 mm, URSUS, AKTIV FISCHER, ALLIS CHALMERS, BERLIET



77 634 600

KOLBENSCHMIDT



**Ložiskové puzdro ojnice** vnútorný priemer 37.994 mm, vonkajší priemer 41.02 mm, šírka 35.3 mm, FENDT, AHLMANN, DEUTZ FAHR, LAMBORGHINI



77 829 690

KOLBENSCHMIDT



**Ložiskové puzdro ojnice** vnútorný priemer 29.99 mm, vonkajší priemer 33.02 mm, šírka 26.4 mm, AHLMANN, ATLAS, GEHL, GEKO



77 728 690

KOLBENSCHMIDT



**Ložiskové puzdro ojnice** vnútorný priemer 34.99 mm, vonkajší priemer 38.016 mm, šírka 33.8 mm, FENDT, ABG, AHLMANN, ATLAS



87 335 600

KOLBENSCHMIDT



**Sada piestných krúžkov** priemer 100.0 mm, veľkosť STD, výška krúžku 1: 3.0 mm, výška krúžku 2: 2.5 mm, výška krúžku 3: 2.5 mm, výška krúžku 4: 5.0 mm, DEUTZ



800012512000

KOLBENSCHMIDT



**Sada piestných krúžkov** priemer 94.0 mm, veľkosť STD, výška krúžku 1: 3.0 mm, výška krúžku 2: 2.0 mm, výška krúžku 3: 3.0 mm, DEUTZ, AHLMANN



800073210000

KOLBENSCHMIDT



**Sada piestných krúžkov** priemer 98.48 mm, veľkosť STD, výška krúžku 1: 2.39 mm, výška krúžku 2: 2.39 mm, výška krúžku 3: 2.39 mm, výška krúžku 4: 6.34 mm, výška krúžku 5: 6.34 mm, PERKINS, AKTIV FISCHER, ALLIS CHALMERS



800016211000

KOLBENSCHMIDT



**Piest** priemer 91.48 mm, veľkosť STD, priemer čapu 31.75 mm, dĺžka čapu 75.3 mm, MASSEY FERGUSON, PERKINS



91 130 600

KOLBENSCHMIDT



**Piest** priemer 101.054 mm, veľkosť +0,10, priemer čapu 34.925 mm, dĺžka čapu 84.2 mm, ALLIS CHALMERS, CLAAS, HANOMAG, LANDINI



92 144 800

KOLBENSCHMIDT



**Piest** priemer 94.5 mm, veľkosť +0,50, priemer čapu 34.0 mm, dĺžka čapu 78.0 mm, DEUTZ



94 900 610

KOLBENSCHMIDT



**Vložka valcov** vnútorný priemer 101.05 mm, vonkajší priemer 104.2 mm, dĺžka 227.2 mm, šírka 3.8 mm, PERKINS, FIAT, IVECO



89 022 190

KOLBENSCHMIDT



**Vložka valcov** vnútorný priemer 98.48 mm, vonkajší priemer 103.22 mm, dĺžka 227.4 mm, šírka 3.8 mm, PERKINS, VOLVO



88 355 190

KOLBENSCHMIDT



**Vložka valcov** vnútorný priemer 100.0 mm, vonkajší priemer 110.75 mm, dĺžka 216.1 mm, šírka 7.72 mm, CASE



89 018 150



## MOTOROVÉ DIELY

**MAHLE**  
ORIGINAL



**Ojničné ložisko** veľkosť 0.25, šírka 33.8 mm - 34.0 mm, pre hrúbku steny od 2.0 mm do 2.135 mm, priemer hriadele od 75.155 mm do 75.175 mm, URSUS



454 PS 20109 025

**MAHLE**  
ORIGINAL



**Ojničné ložisko** veľkosť 0.51, šírka 29.95 mm - 30.2 mm, pre hrúbku steny od 2.07 mm do 2.08 mm, priemer hriadele od 57.112 mm do 57.125 mm, URSUS, CATERPILLAR, FORD, LANDINI, MASSEY FERGUSON



043 PS 18500 220

**MAHLE**  
ORIGINAL



**Ojničné ložisko** šírka 31.65mm - 31.9mm, pre hrúbku steny od 1.832mm do 1.842mm, priemer hriadele od 63.474 mm do 63.487 mm, AKTIV FISCHER, ALLIS CHALMERS, BERLIET, CATERPILLAR, CLAAS, CLARK



043 PS 18359 200

**MAHLE**  
ORIGINAL



**Vymedzovacia podložka pre kľukový hriadel'** veľkosť STD, pre hrúbku steny od 2.9 mm do 2.95 mm, priemer hriadele od 76.0 mm do 76.25 mm, URSUS



454 AS 20123 000

**MAHLE**  
ORIGINAL



**Vymedzovacia podložka pre kľukový hriadel'** pre hrúbku steny od 3.33 mm do 3.41 mm, priemer hriadele od 128.4 do 128.75 mm, LIEBHERR A, HS, LTM, R, D



151 HL 18607 000

**MAHLE**  
ORIGINAL



**Vymedzovacia podložka pre kľukový hriadel'** pre hrúbku steny od 2.89mm do 2.95mm, priemer hriadele od 91.4 do 91.7mm, VOLVO, MAZ, FENDT, ATLAS, DEUTZ FAHR



209 AS 21577 000

**MAHLE**  
ORIGINAL



**Sada piestných krúžkov** priemer 103.0 mm, výška krúžku 1: 2.5 mm, výška krúžku 2: 2.5 mm, výška krúžku 3: 3.5 mm, URSUS, JCB, LANDINI, MANITOU, MASSEY FERGUSON



043 76 NO

**MAHLE**  
ORIGINAL

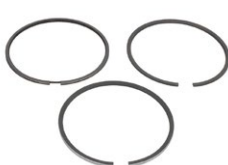

**Sada piestných krúžkov** priemer 105.0 mm, výška krúžku 1: 3.5 mm, výška krúžku 2: 2.5 mm, výška krúžku 3: 3.5 mm, LANDINI



043 93 NO

**MAHLE**  
ORIGINAL

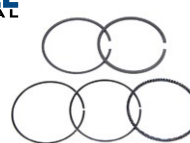

**Sada piestných krúžkov** priemer 111.76 mm, výška krúžku 1: 3.19 mm, výška krúžku 2: 2.38 mm, výška krúžku 3: 4.75 mm, NEW HOLLAND



257 15 NO

**MAHLE**  
ORIGINAL



**Piest** priemer 104.0 mm, veľkosť STD, priemer čapu 38.0 mm, dĺžka čapu 82.0 mm, CASE, NEW HOLLAND



010 27 00

**MAHLE**  
ORIGINAL



**Piest** priemer 91.48 mm, priemer čapu 31.75 mm, dĺžka čapu 75.31 mm, URSUS, FORD, LANDINI



043 78 00

**MAHLE**  
ORIGINAL



**Piest** priemer 127.0 mm, priemer čapu 44.7 mm, dĺžka čapu 109.2 mm, JELCZ, LEYLAND



456 24 00

**MAHLE**  
ORIGINAL



**Sada piest/vložka** priemer 95.0 mm, URSUS



454 17 90

**MAHLE**  
ORIGINAL



**Sada piest/vložka** priemer 102.0 mm, ZETOR



595 26 90

**MAHLE**  
ORIGINAL



**Sada piest/vložka** priemer 110.0 mm, URSUS, ZETOR



454 16 90

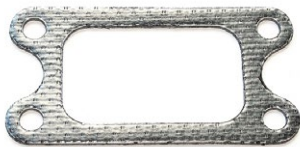

**Tesnenie výfukového potrubia** motory LIEBHERR D904, D906, D914, D916, D924, D926, G924, G926



EL306650

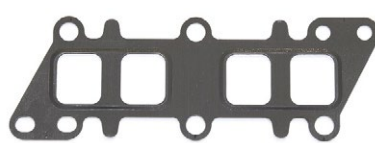

**Tesnenie výfukového potrubia** motory DEUTZ L06 4V DCR, L4 4V, L04 4V, L06 4V



EL363070



**Tesnenie sacieho potrubia** pre stroje s motormi MWM -FENDT, DEUTZ, RENAULT



EL362500

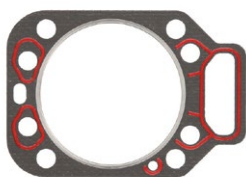

**Tesnenie hlavy valcov** pre motory MWM, hrúbka 1.4 mm, priemer 106.5 mm, FENDT, RENAULT



EL288374



**Tesnenie hlavy valcov** pre motory AGRALE, FORD USA, MWM, hrúbka 1.4 mm, priemer 110.0 mm, FENDT, CASE, NEW HOLLAND, RENAULT



EL306519



**Tesnenie hlavy valcov** pre motory LIEBHERR D934, D936, D944, D946, G944, G946, hrúbka 1.25 mm, priemer 131.5 mm,



EL586890



**Tesnenie hlavy valcov** hrúbka 1.5 mm, priemer 115.0 mm, FORD AGRO séria 5000, 6000, 7000



EL647090



**Tesnenie hlavy valcov** hrúbka 1.4 mm, priemer 119.0 mm, MAZ 100, CLAAS, DEUTZ, LAMBORGHINI, RENAULT, SAME



EL977137



**Tesnenie hlavy valcov** hrúbka 1.6 mm, priemer 119.0 mm, MAZ, DEUTZ



EL977153



**Tesnenie veka ventilov** FORD, FENDT, AGRALE, AGRIFULL, CASE, NEW HOLLAND



EL517897



**Tesnenie veka ventilov** pre motory LIEBHERR D9406, D9408, G9408



EL634090



**Tesnenie veka ventilov** pre motory DEUTZ BF 6. - FENDT, AHLMANN, DEUTZ, LAMBORGHINI



EL153781

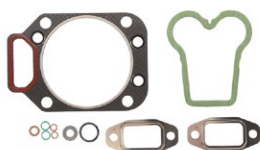

**Sada tesnení hlavy valcov** FENDT s motorom MWM D226



EL056670



**Sada tesnení hlavy valcov** pre motory LIEBHERR D924, D926, G924, G926



EL306740

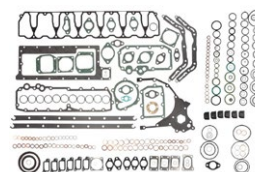

**Kompletná sada tesnení motora** pre motory DEUTZ BF 6L 1012 a DEUTZ BF 6M 1012 - FENDT, DEUTZ



EL330151



## MOTOROVÉ DIELY



**Tesnenie sacieho potrubia** AKTIV FISCHER, ALLIS CHALMERS, BERLIET, BROOME & VADE, CATERPILLAR, CLAAS



71-41594-00



**Tesnenie výfukového potrubia** FENDT, AHLMANN, ATLAS, BOMAG, CLAAS, DEUTZ, LAMBORGHINI



71-28747-10



**Tesnenie výfukového potrubia** IVECO, AGCO, CASE



71-23727-50

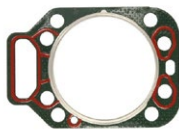

**Tesnenie hlavy valcov** pre motor MWM D226, hrúbka 1.2 mm, priemer 106.0 mm, FENDT, RENAULT



61-24305-40



**Tesnenie hlavy valcov** hrúbka 1.8 mm, priemer 146.0 mm, DEUTZ, GIGANT



61-36485-20



**Tesnenie hlavy valcov** pre ATLAS COPCO QAS/QAX 1.6, hrúbka 1.65 mm



61-37495-10



**Tesnenie hlavy valcov** pre motor PERKINS 1106C-E60TA, priemer 104.0 mm, CATERPILLAR, LANDINI, MASSEY FERGUSON



61-41495-00

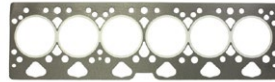

**Tesnenie hlavy valcov** pre motor PERKINS 6.354.4, hrúbka 1.5 mm, priemer 104.0 mm, URSUS, BROYT, CLARK, HYSTER, JCB, LANDINI, MASSEY FERGUSON



61-41825-00

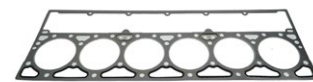

**Tesnenie hlavy valcov** pre motor CUMMINS LT 10, priemer 134.0 mm, CHAMPION, INGERSOLL, KOMATSU



61-41460-00



**Sada tesnení hlavy valcov** pre stroje s motormi DEUTZ F1, F2, F3, F4 - CASE, CLASS, DEUTZ, KRAMER



03-12612-04

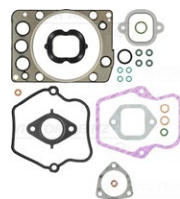

**Sada tesnení hlavy valcov** pre motor MERCEDES OM 457 - HITACHI, MERCEDES



03-34285-05



**Sada tesnení hlavy valcov** IVECO, FENDT, ABG ALEXANDER, AGCO, AHLMANN



03-12612-05

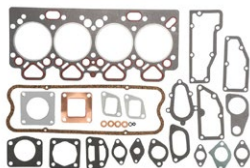

**Sada tesnení hlavy valcov** AKTIV FISCHER, CLARK, CATERPILLAR, CLAAS



02-41765-01



**Sada tesnení hlavy valcov** pre motor PERKINS PHASER 110 T - BOBCAT, CASE, CLASS, LANDINI, MANITOU



02-41465-01

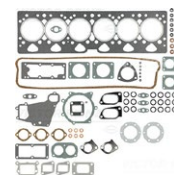

**Sada tesnení hlavy valcov** pre motor PERKINS 6.354.4 - URSUS, BROY, CLARK, HANOMAG, JCB, LANDINI, MASSEY FERGUSON



02-55919-01



**Tesnenie sacieho potrubia** pre motory DEUTZ BF4, BF6 - FENDT, DEUTZ FAHR



ENT010301



**Tesnenie výfukového potrubia** MASSEY FERGUSON, PERKINS



ENT010338



**Tesnenie výfukového potrubia** pre motory CUMMINS 6 CT, 6 CT 8.3, 6 CTA 8.3 -AGCO, CASE, FORD, JOHN DEERE, MASSEY FERGUSON



ENT010327



**Tesnenie hlavy valcov** hrúbka 1.6 mm, ZETOR, DEUTZ, LAMBORGHINI,



ENT010058



**Tesnenie hlavy valcov** hrúbka 1.4 mm, SAME LASER 5.7D



ENT010064



**Tesnenie hlavy valcov** hrúbka 1.6 mm, DEUTZ, HUERLIMANN, LAMBORGHINI, SAME



ENT010264



**Tesnenie hlavy valcov** KUBOTA ST 35 ALPHA, STV 36, STV 40, U 35-4



ENT010774

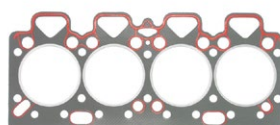

**Tesnenie hlavy valcov** pre motor PERKINS 4.236 - AKTIV FISCHER, ALLIS CHALMERS, BERLIET, BROOME & VADE, CATERPILLAR, CLAAS



ENT010095

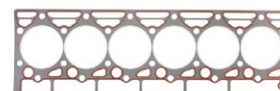

**Tesnenie hlavy valcov** INTERNATIONAL HARVESTER, CASE, KOMATSU



ENT010026



**Sada tesnení hlavy valcov** horná sada tesnení, hrúbka 1.5 mm, ZETOR



ENT000502

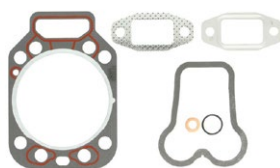

**Sada tesnení hlavy valcov** horná sada tesnení, FENDT, RENAULT



ENT000311

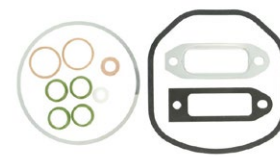

**Sada tesnení hlavy valcov** horná sada tesnení DEUTZ FAHR 3.8D/5.7D



ENT000253

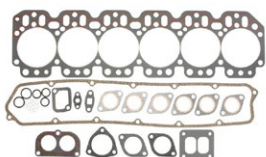

**Kompletná sada tesnení motora** horná sada tesnení, JOHN DEERE 3000, 4000, 6000, RENAULT ARES 5.4-7.6



ENT000351

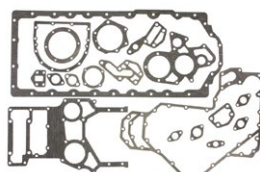

**Kompletná sada tesnení motora** spodná sada tesnení, ZETOR, FIATALLIS, JCB, KALMAR, KOMATSU, LANDINI, MASSEY FERGUSON



ENT000183

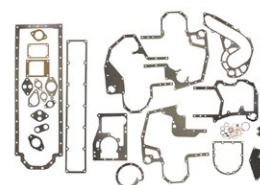

**Kompletná sada tesnení motora** spodná sada tesnení, CASE, KOMATSU, INTERNATIONAL HARVESTER



ENT000170



## MOTOROVÉ DIELY

**Letrika**



**Alternátor** napätie 14V, nabíjací prúd 150A, s remenicou, CASE, NEW HOLLAND



**MG 30**

**Letrika**



**Alternátor** napätie 14V, nabíjací prúd 120A, bez remenice, JOHN DEERE 5000, 6000



**MG 4**

**Letrika**



**Alternátor** napätie 14V, nabíjací prúd 90A, bez remenice, JOHN DEERE 5000, 6000, FENDT 900



**MG 329**

**CARGO**



**Alternátor** napätie 28V, nabíjací prúd 70A, bez remenice, CUMMINS, HYSTER, JCB



**CART16317**

**CARGO**



**Alternátor** napätie 14V, nabíjací prúd 90A, s remenicou, BOBCAT



**CART13600**

**CARGO**



**Alternátor** napätie 14V, nabíjací prúd 65A, s remenicou, CASE, CATERPILLAR, CUMMINS, JOHN DEERE



**CART11888**

**BOSCH**



**Alternátor** napätie 14V, nabíjací prúd 200A, bez remenice, JOHN DEERE, FENDT



**1986 A00 957**

**BOSCH**



**Alternátor** napätie 28V, nabíjací prúd 100A, bez remenice, FENDT



**1986 A00 977**

**BOSCH**



**Alternátor** napätie 28V, nabíjací prúd 55A, bez remenice, CASE, FORD AGRO, KHD, LIEBHERR



**0 986 034 430**

**DENSO**



**Alternátor** napätie 14V, nabíjací prúd 90A, s 8 drážkovou remenicou, CASE



**DAN2013**

**DENSO**



**Alternátor** napätie 14V, nabíjací prúd 60A, s 1 drážkovou remenicou, TOYOTA



**DAN2014**

**DENSO**



**Alternátor** napätie 14V, nabíjací prúd 75A, bez remenice, PERKINS, JCB, LANDINI



**DAN654**

**DENSO**



**Alternátor** napätie 14V, nabíjací prúd 65A, bez remenice, PERKINS



**DAN653**

**DENSO**



**Alternátor** napätie 14V, nabíjací prúd 85A, s 2 drážkovou remenicou, LANDINI



**DAN2043**

**DENSO**



**Alternátor** napätie 14V, nabíjací prúd 120A, bez remenice, CATERPILLAR, CLAAS, MASSEY FERGUSON



**DAN1092**



**Letrika**



**Štartér** napätie 12V, výkon 3.2kW, priemer príruby 89 mm, počet zubov 11, FENDT



MS 235

**Letrika**



**Štartér** napätie 12V, výkon 4.2kW, priemer príruby 92 mm, počet zubov 10, CASE, NEW HOLLAND



MS 64

**Letrika**



**Štartér** napätie 12V, výkon 3kW, priemer príruby 89 mm, počet zubov 11, URSUS, CLAAS, MASSEY FERGUSON



MS 184

**STARDAX**  
AUTOMOTIVE PARTS



**Štartér** napätie 12V, výkon 2kW, priemer príruby 74 mm, počet zubov 9, BOBCAT, CATERPILLAR, JCB, JUNGHEINRICH, MITSUBISHI



STX210178

**STARDAX**  
AUTOMOTIVE PARTS



**Štartér** napätie 12V, výkon 2.7kW, priemer príruby 89 mm, počet zubov 9, FENDT,



STX210075

**STARDAX**  
AUTOMOTIVE PARTS



**Štartér** napätie 12V, výkon 2.5kW, priemer príruby 88.8 mm, počet zubov 10, CASE, CUMMINS, BOMAG



STX210182

**BOSCH**



**Štartér** napätie 12V, výkon 2kW, priemer príruby 83 mm, počet zubov 9, BELARUS, CARRARO, FIAT AGRI



1986 500 718

**BOSCH**



**Štartér** napätie 12V, výkon 2.3kW, priemer príruby 82.5 mm, počet zubov 9, KHD, AHLMANN



1986 500 755

**BOSCH**



**Štartér** napätie 12V, výkon 4kW, priemer príruby 89 mm, počet zubov 11, JOHN DEERE



1986 S10 041

**DENSO**



**Štartér** napätie 12V, výkon 4.8kW, počet zubov 10, JOHN DEERE



DSN2092

**DENSO**



**Štartér** napätie 12V, výkon 4kW, priemer príruby 89 mm, počet zubov 10, CUMMINS



DSN2091

**DENSO**



**Štartér** napätie 12V, výkon 4.5kW, priemer príruby 89 mm, počet zubov 10, CATERPILLAR, BOBCAT, MASSEY FERGUSON



DSN2058

**DENSO**



**Štartér** napätie 12V, výkon 2.2kW, priemer príruby 95 mm, počet zubov 9, CUMMINS, KOMATSU



DSN2062

**DENSO**



**Štartér** napätie 12V, výkon 1kW, priemer príruby 66 mm, počet zubov 9, KUBOTA



DSN2075

**DENSO**



**Štartér** napätie 12V, výkon 1.4kW, priemer príruby 89mm, počet zubov 10, BOBCAT



DSN2127



## MOTOROVÉ DIELY

Turbolader



**Plniace dúchadlo** nové plniace dúchadlo bez premenlivej geometrie, CASE, CLAAS, NEW HOLLAND

**KKK53039880516**

Turbolader



**Plniace dúchadlo** repasované plniace dúchadlo bez premenlivej geometrie, FENDT VARIO, DEUTZ, LAMBORGHINI

**KKK12709900013**

Turbolader



**Plniace dúchadlo** nové plniace dúchadlo bez premenlivej geometrie, FENDT VARIO, DEUTZ, LAMBORGHINI

**KKK12709880013**

**HOLSET**  
TURBOCHARGERS



**Plniace dúchadlo** nové plniace dúchadlo bez premenlivej geometrie, CUMMINS

**HOL4033364**

**HOLSET**  
TURBOCHARGERS



**Plniace dúchadlo** nové plniace dúchadlo bez premenlivej geometrie, so sadou tesnení, CASE

**HOL4045361**

**HOLSET**  
TURBOCHARGERS



**Plniace dúchadlo** nové plniace dúchadlo bez premenlivej geometrie, so sadou tesnení, CASE, CUMMINS, NEW HOLLAND

**HOL4046106**

**Schwitzer**



**Plniace dúchadlo** nové plniace dúchadlo s premenlivou reguláciou a elektronickým ovládaním, JOHN DEERE

**SWZ178737**

**Schwitzer**



**Plniace dúchadlo** nové plniace dúchadlo bez premenlivej geometrie, CLAAS, DEUTZ, KHD

**SWZ319261**

**Schwitzer**



**Plniace dúchadlo** nové plniace dúchadlo bez premenlivej geometrie, CLAAS, DEUTZ, KHD, FENDT, VOLVO

**SWZ318279**

**Garrett**  
ADVANCING MOTION



**Plniace dúchadlo** repasované plniace dúchadlo bez premenlivej geometrie, JCB

**727266-5001W**

**Garrett**  
ADVANCING MOTION



**Plniace dúchadlo** nové plniace dúchadlo bez premenlivej geometrie, PERKINS, JCB

**466854-5001S**

**Garrett**  
ADVANCING MOTION



**Plniace dúchadlo** nové plniace dúchadlo bez premenlivej geometrie, so sadou tesnení, MASSEY FERGUSON

**711736-5026W**

**Garrett**  
ADVANCING MOTION



**Plniace dúchadlo** nové plniace dúchadlo bez premenlivej geometrie, JCB 4.4 Dieselmex Euro 2

**762931-5009S**

**Garrett**  
ADVANCING MOTION



**Plniace dúchadlo** nové plniace dúchadlo bez premenlivej geometrie, PERKINS CA 4.236

**465778-0016**

**Garrett**  
ADVANCING MOTION



**Plniace dúchadlo** nové plniace dúchadlo bez premenlivej geometrie, NEW HOLLAND, FORD AGRO

**452134-0002**





Spínač stieračov, FENDT 300, 600, 700



11245250XX



Spínač výstražných svetiel DEUTZ



11105020XX



Spínač START/STOP, RENAULT AGRI



11245420XX



Spínač svetlometov DEUTZ



11120140XX



Spínač parkovacích svetiel DEUTZ, VALTRA



11125160XX



Spínač majáku FENDT, DEUTZ



11140120XX



Spínač ventilátora kúrenia FENDT



11145160XX



Spínač hmlových svetiel MASSEY FERGUSON



11130070XX



Spínač uzávierky diferenciálu DEUTZ



11130420XX



Kľúč zapalovania MASSEY FERGUSON



205 100 07



Spínač zapalovania FENDT



205 005 01



Spínač zapalovania CASE



205 001 04



Spínač brzdových svetiel CASE



171 047 000



Snímač tlaku oleja DEUTZ



111 295 000



Snímač tlaku oleja: JOHN DEERE



131 300 000



# Palivový systém

Stále prísnejšie emisné normy a požiadavky na nízku spotrebu paliva sú spojené s ďalšími podmienkami, ktorým sa musí prispôsobiť vstrekovací systém a riadiaci systém naftového motora. Na splnenie týchto požiadaviek a dosiahnutie správnej zmesi musí vstrekovací systém vstrekať presné množstvo paliva do spaľovacej komory pod vysokým tlakom. V tradičnom napájacom systéme naftového motora sa používa rotačné čerpadlo, ktoré je relatívne jednoduché na zostavenie a lacné na opravu alebo nákup. Napriek mnohým výhodám sa tento systém postupne nahrádza novšími systémami vstrekovania paliva. Je to spôsobené najmä vysokými emisiami oxidu uhličitého na jednotku práce. Elektronické, veľmi presné ovládanie vstrekovačov je preto charakteristické pre moderné systémy Common Rail. To umožňuje rozdeliť prácu vstrekovača do niekoľkých etáp v závislosti od aktuálneho stavu chodu motora. Systém Common Rail umožňuje dosiahnuť plynulejší chod, nižšiu spotrebu paliva, lepší výkon a nižšiu hlučnosť a emisie výfukových plynov.

**BOSCH**Delphi  
Technologies**Stanadyne®****Uzáver palivovej nádrže** priemer 67 mm,  
FIAT, SOMECA, CNH

AG 0429

**Uzáver palivovej nádrže** priemer 68 mm,  
LANDINI, MASSEY FERGUSON

AG 0212

**Uzáver palivovej nádrže** priemer 28 mm,  
JOHN DEERE

AG 0205

**Ventil palivovej nádrže** odvetrávací ventil  
palivovej nádrže NEW HOLLAND

AG 0158

**Ventil palivovej nádrže** odvetrávací ventil  
palivovej nádrže MASSEY FERGUSON

AG 0161

**Ventil regulácie tlaku paliva** JOHN DEERE  
6000, 7000

AG 0073

**Senzor teploty paliva** JOHN DEERE, OE  
číslo RE506424

AG 0131

**Senzor tlaku paliva** JOHN DEERE 6000,  
7000, 8000, OE číslo RE538127

AG 0133

**Senzor tlaku paliva** pre motory DEUTZ, 3  
pin, závit M14x1,5 mm

AG 0532



**BOSCH**



**Palivové čerpadlo** elektrické palivové čerpadlo, napätie 12V, výtlak 6.1L/min



0 580 464 117

**BOSCH**



**Palivové čerpadlo** mechanické palivové čerpadlo JOHN DEERE



0 440 008 125

**BOSCH**



**Palivové čerpadlo** mechanické palivové čerpadlo CUMMINS, KOMATSU, KAMAZ



0 440 020 096

**BOSCH**



**Vstrekovacie čerpadlo** pre motor DEUTZ 1011



0 414 287 005

**BOSCH**



**Vstrekovacie čerpadlo** CASE, SAME



0 414 191 008

**BOSCH**



**Vstrekovacie čerpadlo** DEUTZ FAHR, LAMBORGHINI



0 414 491 109

**BOSCH**



**Vysokotlaké čerpadlo** NEW HOLLAND T6, T7, 08.10-



0 445 020 223

**BOSCH**



**Vysokotlaké čerpadlo** CUMMINS QSB4.5, QSB6.7



0 445 020 176

**BOSCH**



**Vysokotlaké čerpadlo** pre motor AGCO 33CTA - FENDT, MASSEY FERGUSON, SISU



0 445 020 056

**BOSCH**



**Vstrekovacia tryska** typ DLLA150P115, CASE, CUMMINS, FIAT, IVECO, DRESSER



0 433 171 104

**BOSCH**



**Vstrekovacia tryska** typ DLLA150S925, CASE, LAMBORGHINI, SAME



0 433 271 804

**BOSCH**



**Vstrekovacia tryska** typ DLLA152S1180, FENDT, STEYR, CASE



0 433 271 691

**BOSCH**



**Vstrekovač** FENDT VARIO rada 200, MASSEY FERGUSON 3000 3.3D, 09.10-



0 445 110 381

**BOSCH**



**Vstrekovač** FENDT, DEUTZ, LAMBORGHINI, SAME



0 445 120 246

**BOSCH**



**Vstrekovač** NEW HOLLAND T6.155, T6.165, T6.175, T7.210



0 986 435 678



## PALIVOVÝ SYSTÉM

Delphi  
Technologies



**Palivové čerpadlo** mechanické palivové čerpadlo, PERKINS, MASSEY FERGUSON



DELHFP184

Delphi  
Technologies



**Palivové čerpadlo** mechanické palivové čerpadlo, CUMMINS



DELHFP702

Delphi  
Technologies

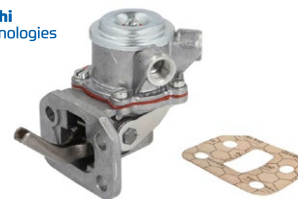

**Palivové čerpadlo** mechanické palivové čerpadlo, PERKINS, MASSEY FERGUSON, CASE, JCB



DELHFP664

Delphi  
Technologies



**Vstrekovacie čerpadlo** JCB 3CX, 4CX, 1600B, 1700B



DEL9520A290G

Delphi  
Technologies



**Vstrekovacie čerpadlo** pre motory JOHN DEERE 6068, 6068T



DEL8921A080W

Delphi  
Technologies



**Vstrekovacie čerpadlo** pre motory PERKINS DARWIN LC11.2, PERKINS DARWIN LC11.2 200 - MASSEY FERGUSON, PERKINS, JCB, CAT



DEL8921A750G

Delphi  
Technologies



**Vstrekovacia tryska** typ DLLA150S6372, JCB, MASSEY FERGUSON, VOLVO, PERKINS



DEL5621120

Delphi  
Technologies



**Vstrekovacia tryska** typ DLLA150S469, PERKINS, MASSEY FERGUSON, CATERPILLAR



DEL5621513

Delphi  
Technologies



**Vstrekovacia tryska** typ DLLA150S824, NEW HOLLAND



DEL5621595

Delphi  
Technologies



**Vstrekovač** PERKINS VISTA D, CATERPILLAR



DELB04801A

Delphi  
Technologies



**Vstrekovač** pre motor PERKINS 1006-6T



DEL6701419

Delphi  
Technologies



**Vstrekovač** OE číslo 320/06838, JCB 3CX, 4CX



DELB05502A

Delphi  
Technologies



**Vstrekovač** pre motory PERKINS 1104C-44T, 1104C-44TA



DELB03201A

Delphi  
Technologies



**Vstrekovač** motor PERKINS AD3.152 -PERKINS, MASSEY FERGUSON



DEL5281620

Delphi  
Technologies



**Vstrekovač** pre motory PERKINS 4.4l, 1006-6 - JCB, CATERPILLAR, PERKINS



DEL6701418



Vstrekovacia tryska typ DLL150M9302,  
MASSEY FERGUSON, PERKINS, JCB



7D 70416



Vstrekovacia tryska typ DLLA145M31068,  
LANDINI, MASSEY FERGUSON, PERKINS



7D 76212



Vstrekovacia tryska typ DLLA146P1581,  
DEUTZ, KHD



7D 71905526



Vstrekovacia tryska typ DLLA148P764,  
JOHN DEERE



7D 73824



Vstrekovacia tryska typ DLLA133P814,  
JOHN DEERE



7D 73838



Vstrekovacia tryska typ DLLA148P826,  
JOHN DEERE



7D 738405



Vstrekovacia tryska typ DLL150S6600,  
MASSEY FERGUSON, PERKINS



S29638



Vstrekovacia tryska typ DLLA150S620,  
CASE, MASSEY FERGUSON, VALMET



S770620



Vstrekovacia tryska typ DLLA152M33877,  
MASSEY FERGUSON



S33877



Vstrekovacia tryska typ DLLA145M34447,  
MASSEY FERGUSON, CASE



S34447



Vstrekovacia tryska typ DLLA152M33426,  
CASE, CASE-STEYR



S33426



Vstrekovacia tryska typ DLLA152M35926,  
MASSEY FERGUSON



S35926



Vstrekovač OE číslo RE519569, SE501179,  
SE501180, JOHN DEERE 5000, 6000



S36011



Vstrekovač pre motory JOHN DEERE 3179D  
- 6359T, JOHN DEERE 1000, 2000, 3000



S27333



Vstrekovač OE čísla RE57469, RE60062,  
SE500828, SE500829, SE501102, JOHN  
DEERE



S32262



# Pneumatický systém

Pneumatický systém pozostáva z mnohých prvkov. Jedným najdôležitejších je kompresor. Poháňaný je najčastejšie motorom cez klinový remeň. Kompresor nasáva vzduch z filtra, stláča ho a pumpuje do ďalších prvkov pneumatického systému, akými sú odlučovač oleja, regulátor tlaku, vzduchojem, brzdový ventil a vonkajšie konektory pneumatického systému. Všetky tieto prvky sú navzájom spojené pomocou ocelových hadíc alebo v novších strojoch tekalónových hadíc. Pneumatický tlakový systém umožňuje brzdenie vozidla a prívesov, automatické brzdenie prívesu v prípade odpojenia od ťahača a taktiež použiť stlačený vzduch aj v iných systémoch vozidla alebo pumpovať kolesá.

## WABCO

WABCO



Kompresor pneumatického systému  
zdvihový objem 229 cm<sup>3</sup>, priemer piestu  
90 mm, DEUTZ, FENDT



411 146 003 0

WABCO



Kompresor pneumatického systému  
zdvihový objem 159 cm<sup>3</sup>, priemer piestu  
75 mm, s hnacím kolesom, JOHN DEERE



411 141 102 0

WABCO



Kompresor pneumatického systému  
zdvihový objem 159 cm<sup>3</sup>, priemer piestu  
75 mm, s hnacím kolesom, JOHN DEERE



411 141 003 0

WABCO



Kompresor pneumatického systému  
zdvihový objem 238 cm<sup>3</sup>, priemer piestu  
85 mm, bez hnacieho kolesa, JOHN DEERE



912 125 001 0

WABCO



Kompresor pneumatického systému  
zdvihový objem 159 cm<sup>3</sup>, priemer piestu  
75 mm, bez hnacieho kolesa, DEUTZ



411 141 002 0

WABCO



Kompresor pneumatického systému  
zdvihový objem 159 cm<sup>3</sup>, priemer piestu  
75 mm, bez hnacieho kolesa, CASE, FENDT,  
NEW HOLLAND



411 141 005 0

WABCO



Riadiaci ventil prívesu tlak 20 bar, DEUTZ,  
FENDT, JOHN DEERE, CLAAS



470 015 253 0

WABCO



Riadiaci ventil prívesu tlak 11 bar, CASE



470 015 265 0

WABCO



Riadiaci ventil prívesu tlak 12 bar, CASE,  
DEUTZ, JOHN DEERE



470 015 203 0

# Budúcnosť poľnohospodárstva

S viac ako 80 rokmi skúsenosti sa ZF stal kompletným systémovým dodávateľom, ktorý ponúka technológie šité na mieru pre všetky aplikácie a potreby zákazníkov. K tomu prispieva portfólio produktov pre efektívne, bezemisné a bezpečné poľnohospodárstvo.

⊕ Softvérové riešenie

⊕ Brzdový systém

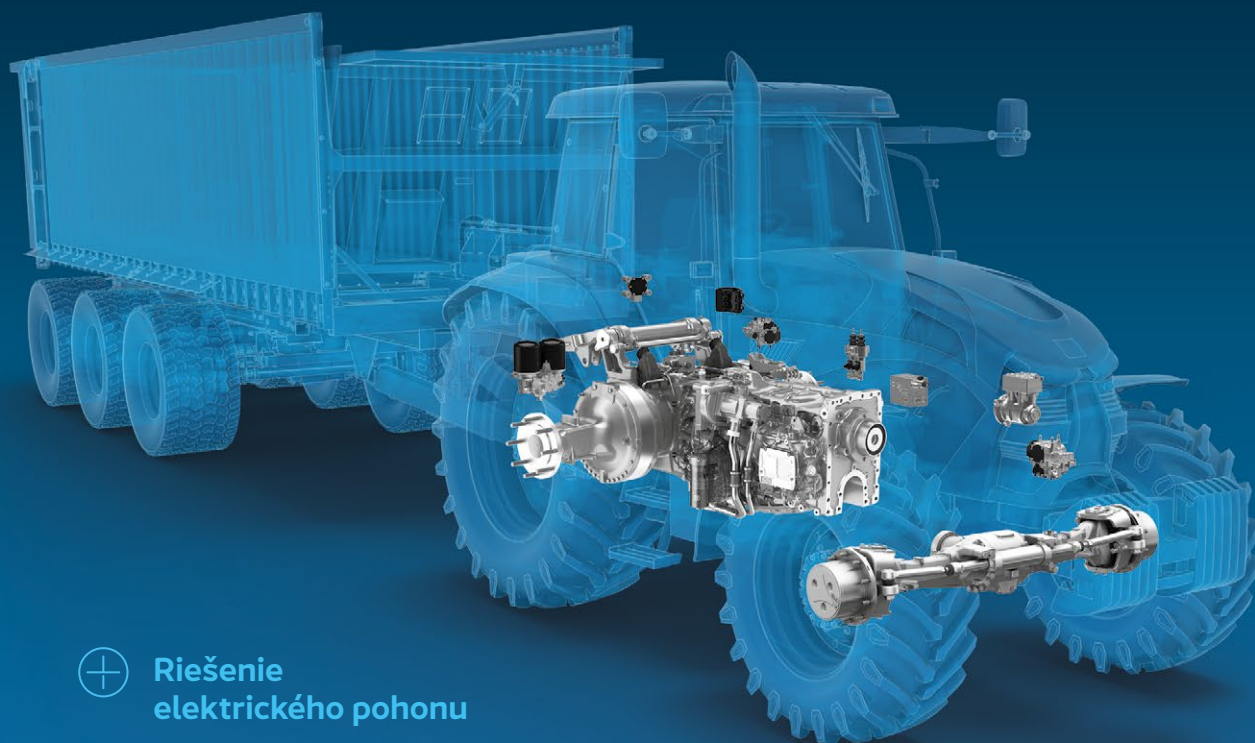

⊕ Riešenie  
elektrického pohonu

⊕ Technológie hnacej sústavy

Navrhujeme a vyvíjame inteligentné systémové riešenia, ktoré prispievajú k vyššej produktivite na poľnohospodárskej pôde, pastvinách a na cestách. V tomto smere majú spoľahlivosť, efektívnosť a udržateľnosť najvyššiu prioritu. [ZF.com/agriculture](https://www.zf.com/agriculture)





# Ponuka AGRO olejov

**PROFITOOL**  
PROFESSIONAL TOOLS & EQUIPMENT

## Ručná pumpa oleja

Univerzálna pumpa pre distribúciu oleja zo sudov od 50L do 200L, kovové telo, výkon 300ml/ zdvih



0XPTJC0070



Názov	Popis	Index	Balenie
<b>KRATOS STOU 10W30</b>	Multifunkčný olej určený pre stavebné a poľnohospodárske stroje, SAE 10W30, API CG-4, GL-4, ACEA E3	KRATOS STOU 10W30 5L	5 l
		KRATOS STOU 10W30 20L	20 l
		KRATOS STOU 10W30 60L	60 l
		KRATOS STOU 10W30 200L	200 l
<b>KRATOS STOU 10W40</b>	Multifunkčný olej určený pre stavebné a poľnohospodárske stroje, SAE 10W40, API CG-4, GL-4, ACEA E3	KRATOS STOU 10W40 5L	5 l
		KRATOS STOU 10W40 20L	20 l
		KRATOS STOU 10W40 60L	60 l
		KRATOS STOU 10W40 200L	200 l
<b>KRATOS UTTO 10W30</b>	Prevodový hydraulický olej určený pre moderné zariadenia používané najmä v poľnohospodárstve. Ideálna voľba pre vozidlá, v ktorých sú manuálna prevodovka, hydraulický systém a „mokré brzdy“ mazané jedným olejovým systémom, SAE 10W30, API GL-4	KRATOS UTTO 10W30 5L	5 l
		KRATOS UTTO 10W30 20L	20 l
		KRATOS UTTO 10W30 60L	60 l
		KRATOS UTTO 10W30 200L	200 l
<b>KRATOS UTTO 10W40</b>	Prevodový hydraulický olej určený pre moderné zariadenia používané najmä v poľnohospodárstve. Ideálna voľba pre vozidlá, v ktorých sú manuálna prevodovka, hydraulický systém a „mokré brzdy“ mazané jedným olejovým systémom, SAE 10W40, API GL-4	KRATOS UTTO 10W40 5L	5 l
		KRATOS UTTO 10W40 20L	20 l
		KRATOS UTTO 10W40 60L	60 l
		KRATOS UTTO 10W40 200L	200 l
<b>KRATOS PTF 10W</b>	Hydraulický prevodový olej typu Power Transmission Fluid určený pre ťažké stavebné a poľnohospodárske zariadenia. Je ideálny pre extrémne prevádzkové podmienky v prevodovkách, prevodovkách s radením pod zaťažením, systémoch prenosu sily a hydraulických systémoch, SAE 10W	KRATOS PTF 10W 5L	5 l
		KRATOS PTF 10W 20L	20 l
		KRATOS PTF 10W 60L	60 l
		KRATOS PTF 10W 200L	200 l
<b>KRATOS UNIV. PTF 30</b>	Hydraulický prevodový olej typu Power Transmission Fluid určený pre ťažké stavebné a poľnohospodárske zariadenia. Je ideálny pre extrémne prevádzkové podmienky v prevodovkách, prevodovkách s radením pod zaťažením, systémoch prenosu sily a hydraulických systémoch. Použitie technológie M-Active v oleji poskytuje oveľa lepšie mazacie vlastnosti v porovnaní s podobnými produktmi dostupnými na trhu. SAE 30W	KRATOS UNIV. PTF 30 5L	5 l
		KRATOS UNIV. PTF 30 20L	20 l
		KRATOS UNIV. PTF 30 60L	60 l
		KRATOS UNIV. PTF 30 200L	200 l
<b>HYDRA REV HL 46</b>	Hydraulický olej určený na použitie v ľahkých a stredne zaťažených systémoch prenosu sily, ako aj hydraulický pohon a ovládanie zariadení s hydrostatickým pohonom, pracujúcich v miernych teplotných podmienkach, viskozita HL 46	HYDRA REV HL 46 5L	5 l
		HYDRA REV HL 46 20L	20 l
		HYDRA REV HL 46 200L	200 l





INTER  
CARS

ORIENTUJTE SA LEPŠIE  
V NAŠOM KATALÓGU

# NEPREHLIADNITE PONUKU OLEJOV A MAZÍV PRE AGRO A PRACOVNÉ STROJE

V ponuke nájdete kompletný  
sortiment olejov a mazív  
od svetových značiek.

1. V hlavnom menu kliknite  
na ponuku "Oleje"

2.

Na zobrazenom filtri vyhladajte  
a aktivujte podmenu "Zmena"  
a tam kliknite na "Agro"

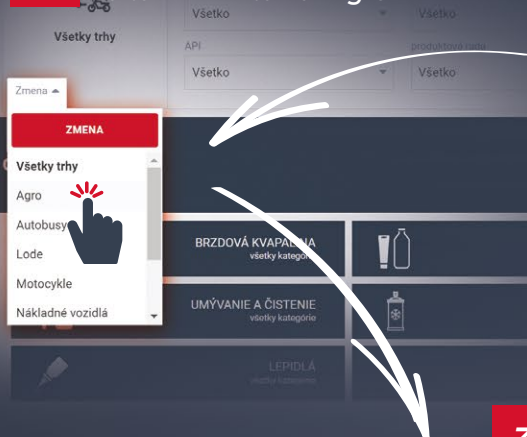

3.

Po zaflirtovaní olejov pre AGRO  
a PRACOVNÉ STROJE filtrujete konkrétne  
parametre oleja o aký máte záujem

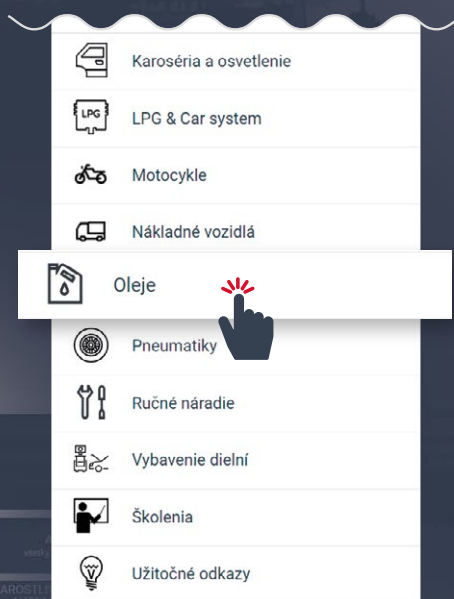

Hľadať Olej pre:  Agro

Zmena ▾

1_MOTOROVÝ OLEJ	2_PREVODOVÝ OLEJ	3_OSTATNÉ OLEJE	4_MAZIVÁ
Viskozita mm <sup>2</sup> /s Všetko ▾	Objem Všetko ▾	Výrobca Všetko ▾	Standard Všetko ▾
API Všetko ▾	produktová rada Všetko ▾		ACEA Všetko ▾
			<input type="button" value="VYHLADÁVANIE"/>



VÝHODNÉ PONUKY NÁJDETE V E-CAT KATALÓGU

WWW.INTERCARS.SK



# Spojky

Spojka je súbor dielov, ktoré sa používajú na spojenie dvoch hriadel'ov: hnacieho hriadeľa a hnaného hriadeľa, aby sa medzi nimi prenášal krútiaci moment. Hovorovo sa týmto pojmom označuje – v prípade automobilov – trecia spojka, čo je spojenie medzi prevodovkou a motorom. Automobilová spojka, ktorá spája motor s prevodovkou, slúži na odpojenie prevodového a výstupného hriadeľa hnacej jednotky, čo má zase umožniť plynulé radenie či zastavenie vozidla. Spojka pozostáva z hnacieho (aktívneho) člena inštalovaného na hnacom hriadeľi, hnaného (pasívneho) člena inštalovaného na hnanom hriadeľi a spojovacích prvkov.



**Lamela spojky** priemer 280 mm, CASE, FIAT, NEW HOLLAND



328 0186 16



**Lamela spojky** priemer 280 mm, CASE, NEW HOLLAND



328 0332 10



**Lamela spojky** priemer 310 mm, DEUTZ FAHR, LAMBORGHINI, MASSEY FERGUSON, SAME



331 0179 11



**Prítlačný tanier spojky** priemer 312 mm, CLAAS, DEUTZ FAHR



131 0208 10



**Prítlačný tanier spojky** priemer 310 mm, CASE MAXXIMA



131 0249 10



**Prítlačný tanier spojky** priemer 330 mm, ZETOR



133 0241 10



**Vodiace ložisko spojky** rozmer 115x75x20 mm, CASE, DEUTZ FAHR, JOHN DEERE, SAME, NEW HOLLAND



500 1292 40



**Vodiace ložisko spojky** rozmer 95x45,5x105 mm, počet prípojk 3, JOHN DEERE



510 0020 10



**Vodiace ložisko spojky** rozmer 95x45,5x105 mm, počet prípojk 2, JOHN DEERE



510 0021 10



# Diagnostika poruchy spojky LUK pri AGRO strojoch



## Čo je ťah spojky ?

Jednou z funkcií spojky je prerušenie pohonu z motora do prevodovky a tým umožňuje hladko zaradiť každý prevodový stupeň. Ak dôjde k neustálemu ťahu spojky, nebude možné hladko zaradiť iný prevodový stupeň.

## Čo je preklzavanie spojky ?

Ďalšou funkciou spojky je prenos pohonu z motora do prevodovky bez straty výkonu. K preklzavaniu spojky dochádza keď sa otáčky motora líšia od otáčok prevodovky.

## Čo je chvenie spojky ?

Vtedy šofér vo vozidle pociťuje vibrácie spojky počas prevádzky, keď je spojka zopnutá. V tomto prípade je pre šoféra ťažké dosiahnuť plynulý rozbeh a následný plynulý pohyb vozidla.

## Čo je hluč spojky ?

Hluč od spojky môže byť dôsledkom zlyhania dielov alebo nadmerným opotrebovaním spojkového systému. Hluč počas vypínania spojky je normálny a súvisí s vypínacím systémom. Avšak hluč pri zábere zvyčajne súvisí s odpružením spojkovvej lamely.



## HLAVNÉ PRÍČINY PROBLÉMOV:

### Zotrvačník

- Povrchová plocha zotrvačníka môže vykazovať známky poškodenia, napr. ryhovanie alebo škrabance
- Musí vždy spĺňať tolerancie stanovené výrobcom
- Pri kontrole zotrvačníka je vhodné vždy skontrolovať ozubené koleso štartéra

### Ložisko zotrvačníka

- Zaseknuté alebo zadreté ložisko môže spôsobiť že sa spojka nebude vypínať
- Poškodené ložisko spôsobuje hluč a vychýlenie vstupného hriadeľa, čím môže dôjsť k poškodeniu ostatných komponentov.

### Olejšové tesnenie

- Netesné olejšové tesnenia sú hlavnou príčinou zlyhania spojky

### Spojková lamela

- Každá spojková lamela by mala byť pred namontovaním skontrolovaná z hľadiska bočného chodu (maximálna tolerancia je 0,5mm)

### Vypínací mechanizmus

- Vypínacie ložisko by sa malo meniť vždy so spojkou
- Vypínacie ložisko by sa malo volne posúvať po vodiacom puzdre bez nakláňania
- Vodiace puzdro treba skontrolovať či je správne upevnené
- Vodiace puzdro by malo byť vždy vycentrované so vstupným hriadeľom prevodovky

- Nadmerná vôľa vo vodiacom puzdre znižuje dráhu vypínacieho ložiska
- Opatrebované, ohnuté alebo zlomené vypínacie vidlice, môžu zabrániť vypínaniu spojky
- Všetky pohyblivé časti treba namazať

### Spojkové lanko

- Pri každej výmene spojky sa odporúča vymeniť aj spojkové lanko
- Pri montáži treba skontrolovať či sú lanká správne namontované

### Hydraulické spojkové ložisko

- Vždy treba použiť presnú špecifikáciu výrobcu a odporúčanú spojkovú kvapalinu

### Montáž

- Pri montáži spojky alebo lamely vždy použite správne nastavovacie nástroje, aby nedošlo k poškodeniu drážky alebo lamely.

### Mazivá

- Na mazanie drážok, vypínacích ložísk a vodiacich puzdier by sa malo používať mazivo ktoré neobsahuje žiadne kovové častice
- Niklované drážkové náboje nevyžadujú žiadne mazanie
- Po nanosení maziva na drážky na vstupnom hriadeľi prevodovky, nasuňte náboj spojkovvej lamely na hriadeľ a odstráňte všetko prebytočné mazivo.



## SPOJKY



**Spojková sada** bez ložiska, priemer 330 mm, ZETOR



633 2404 09



**Spojková sada** kompletná s ložiskom, priemer 310 mm, CASE



631 1067 10



**Spojková sada** bez ložiska, priemer 310 mm, LANDINI



631 3117 09



**Spojková sada** bez ložiska, priemer 300 mm, URSUS, HATTAT TRAKTOR, MASSEY FERGUSON, VALMET



630 3033 19



**Spojková sada** bez ložiska, priemer 310 mm, CASE



631 1364 19



**Spojková sada** bez ložiska, priemer 310 mm, URSUS



631 3126 09



**Spojková sada** kompletná s ložiskom, priemer 310 mm, CASE



633 1391 10



**Spojková sada** bez ložiska, priemer 330 mm, RENAULT AGRI



633 1391 29



**Spojková sada** bez ložiska, priemer 330 mm, RENAULT AGRI



633 1391 09



**Spojková sada** bez ložiska, priemer 280 mm, AGRIFULL, CASE, NEW HOLLAND, FOTON, FIAT AGRI



628 1053 09



**Spojková sada** bez ložiska, priemer 310 mm, CLAAS



631 3056 09



**Spojková sada** bez ložiska, priemer 280 mm, JOHN DEERE



628 3043 09



**Spojková sada** kompletná s ložiskom, priemer 330 mm, FENDT



633 3124 10

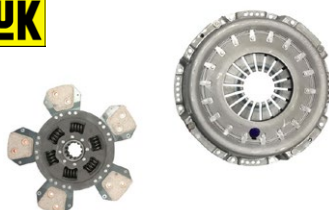

**Spojková sada** bez ložiska, priemer 310 mm, MASSEY FERGUSON



631 3100 09



**Spojková sada** bez ložiska, priemer 350 mm, HUERLIMANN, LAMBORGHINI



635 3045 09



SACHS



**Prítláčny tanier spojky** priemer 310 mm,  
CLAAS, DEUTZ FAHR



3482 008 038

SACHS



**Prítláčny tanier spojky** priemer 330 mm,  
DEUTZ FAHR



3482 600 101

SACHS



**Prítláčny tanier spojky** priemer 310 mm,  
LANDINI



1888 876 006

SACHS



**Prítláčny tanier spojky** priemer 350 mm,  
MERCEDES MB TRAC



1888 998 902

SACHS



**Prítláčny tanier spojky** priemer 330 mm,  
ZETOR, JOHN DEERE



3482 600 107:009

SACHS



**Prítláčny tanier spojky** priemer 280  
mm, LANDINI, MC CORMICK, MASSEY  
FERGUSON



1888 892 001

SACHS



**Prítláčny tanier spojky** priemer 350 mm,  
CASE



1888 864 002

SACHS



**Prítláčny tanier spojky** priemer 310 mm,  
RENAULT AGRI



1888 868 009

SACHS



**Prítláčny tanier spojky** priemer 310  
mm, AGRIFULL, FIAT AGRI, FOTON, NEW  
HOLLAND



1888 600 133:009

SACHS



**Lamela spojky** priemer 354 mm, CASE, MC  
CORMICK



1866 600 002

SACHS



**Lamela spojky** priemer 435 mm, CLAAS



1866 000 108

SACHS



**Lamela spojky** priemer 345 mm,  
LIEBHERR



1866 000 332

SACHS



**Lamela spojky** priemer 295 mm, LANDINI,  
MC CORMICK



1866 600 003

SACHS



**Lamela spojky** priemer 280 mm, URSUS,  
CARRARO, CLAAS, JOHN DEERE, CASE,  
DEXHEIMER



1864 600 351:009

SACHS



**Vodiace ložisko spojky** rozmer 95x45,5x105  
mm, počet prípojok 2, JOHN DEERE



3182 001 105



# KAWE AGRI / INDUSTRY

KOMPLETNÝ SORTIMENT PRESNE SKONŠTRUOVANÝCH KOMPONENTOV PRE STAVEBNÍCTVO, POĽNOHOSPODÁRSTVO A INÉ ODVETVIA

Značka KAWE ponúka najkompletnejšie pokrytie dielov spojky traktorov dostupných na európskom nezávislom trhu, s náhradnými dielmi. S našim sortimentom viac ako 2000 referencií spojok pre poľnohospodárske stroje ponúkame riešenia pre viac ako 80 značiek traktorov. Od A(gria) po Z(etor) sú zastúpené všetky značky. Sme skutočne v jedinečnej pozícii dodať našim zákazníkom takmer kompletný sortiment spojok pre takmer všetky modely traktorov.



Vďaka veľkým investíciám do našich zásob môže KAWE dodať väčšinu objednávok priamo zo skladu. A v prípade, že požadované diely nie sú na sklade, náš výrobný tím ich dokáže vyrobiť efektívne a rýchlo. Spojky spoločnosť distribuuje cez vybraných distribútorov a predajcov vo viac ako 70 krajinách od Ruska po Austráliu.

## Prečo KAWE?

KAWE je jediným nezávislým výrobcom na trhu v Európe s vlastnou výrobou spojok na traktory. S viac ako 50 ročnými skúsenosťami ako výrobca ponúkame našim zákazníkom len diely na úrovni kvality OE. Naši nároční zákazníci nás ohodnotili priemerným skóre 9,41 (z 10) v kategórii „kvalita“

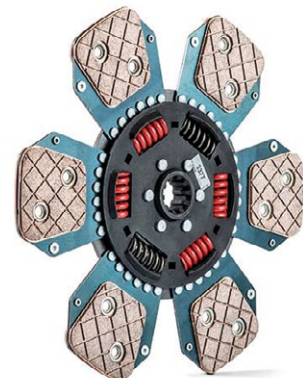
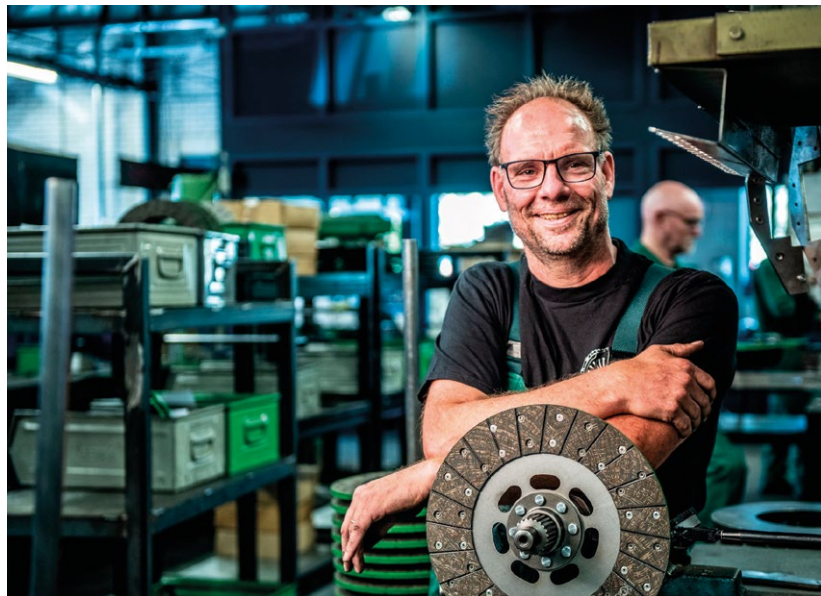



**KAWÉ**  
HOLLAND



**Spojková sada** bez ložiska, priemer 280 mm, AGRIFULL, CASE, FIAT



8113103 KW

**KAWÉ**  
HOLLAND



**Spojková sada** bez ložiska, priemer 350 mm, HUERLIMANN, LAMBORGHINI, DEUTZ FAHR



6162101 KW

**KAWÉ**  
HOLLAND



**Spojková sada** bez ložiska, priemer 300 mm, URSUS, HATTAT TRAKTOR, MASSEY FERGUSON, VALMET



8436101 KW

**KAWÉ**  
HOLLAND



**Spojková sada** bez ložiska, priemer 330 mm, JOHN DEERE



8311101 KW

**KAWÉ**  
HOLLAND



**Spojková sada** bez ložiska, priemer 310 mm, DEUTZ



8338100 KW

**KAWÉ**  
HOLLAND



**Spojková sada** bez ložiska, priemer 330 mm, RENAULT AGR1



8157101 KW

**KAWÉ**  
HOLLAND



**Spojková sada** bez ložiska, priemer 310 mm, URSUS



8475101 KW

**KAWÉ**  
HOLLAND



**Spojková sada** kompletná s ložiskom, priemer 330 mm, CLAAS, RENAULT AGR1



8157505 KW

**KAWÉ**  
HOLLAND



**Lamela spojky** priemer 263 mm, CASE



2938N KW

**KAWÉ**  
HOLLAND



**Prítlačný tanier spojky** priemer 200 mm, FENDT



5519 KW

**KAWÉ**  
HOLLAND

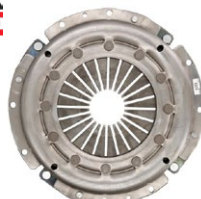

**Prítlačný tanier spojky** priemer 330 mm, HUERLIMANN, LAMBORGHINI



6253 KW

**KAWÉ**  
HOLLAND



**Prítlačný tanier spojky** priemer 225 mm, FENDT, URSUS, CASE



5507 KW

**KAWÉ**  
HOLLAND



**Prítlačný tanier spojky** priemer 305 mm, CASE, MANITOU



6265 KW

**KAWÉ**  
HOLLAND



**Prítlačný tanier spojky** priemer 330 mm, HUERLIMANN, MARSHALL, SAME



6155 KW

**KAWÉ**  
HOLLAND



**Vodiace ložisko spojky** rozmer 75x115x20 mm, univerzál AGRO



9693 KW



## OE AGCO



**Olejový filter** MASSEY FERGUSON, CASE, výška 135 mm, závit M24X1,5 mm



V836679586-AGCO



**Olejový filter** MASSEY FERGUSON, výška 126 mm, závit M22X1,5 mm



V837079728-AGCO



**Olejový filter** MASSEY FERGUSON, VOLVO PENTA, DEUTZ FAHR, výška 171 mm, závit 3/4-16 UNF



1447031M2-MF



**Hydraulický odvzdušňovací filter**, závit M22x1,5 mm



G260860060050-AGCO



**Filter odvetrania** nádrže, závit M42x2 mm



F835860061020-AGCO



**Filter odvetrania** nádrže, závit M30x1,5 mm



X820001191000-AGCO



**Snímač** rýchlosti hriadeľa prevodovky



G931970020043-AGCO



**Snímač** teploty výfukových plynov MASSEY FERGUSON



V837086231-MF



**Snímač** neutrálu na prevodovke, MASSEY FERGUSON, CLAAS



3795429M1-MF



**Tesnenie** turbodúchadla, MASSEY FERGUSON, FENDT



V836316726-AGCO



**Tesnenie** veka ventilov MASSEY FERGUSON - motor PERKINS



4226712M1-MF



**Tesnenie** veka ventilov VALTRA, LANDINI, MASSEY FERGUSON



V837067881-AGCO



**Tesniaci krúžok** prevodovky MASSEY FERGUSON, rozmer 35x2,5 mm



366434X1-MF



**Tesniaci krúžok** prevodovky MASSEY FERGUSON, rozmer 30x5 mm



3010466X1-MF



**Snímač** tlaku oleja MASSEY FERGUSON, LANDINI, závit 1/8-27 NPT



1877721M92-MF





**Palivová hadica** prívodu paliva



528360400



**Palivová hadica** vysokotlaké palivové potrubie



493597400



**Palivová hadica** vrátne potrubie injektora



499513600



**Snímač Nox** pred katalyzátorom, motor CUMMINS PX7



432686700X



**Snímač Nox** pred katalyzátorom, motor CUMMINS PR-7



432686200



**Snímač Nox** za katalyzátorom, motor CUMMINS PR-5



432686400



**Snímač tlakov filtra** DPF



438399800



**Snímač** plniaceho tlaku a teploty prívodu vzduchu



289733300



**Snímač tlaku** výfukových plynov



492859400



**Filter** ventilácie kľukovej skrine pre CUMMINS ISB 6,7, výška 76,40 mm, šírka 175,60 mm



493663600



**Žeraviaca sviečka** pre motory CUMMINS CNG



547300900



**Termostat chladenia**, otváracia teplota 82°C



529270800



**Olejové tesnenie** prídavného čerpadla



489689700



**Výfukové tesnenie**, motor CUMMINS PX-7



493261500



**Tesnenie** EGR ventilu, motor CUMMINS PX-5



397976900



## OE JCB

**JCB**



**Filter** hydraulický filter umiestnený v nádrži, výška 130 mm, vonkajší priemer 124 mm



333/C6860

**JCB**



**Filter** hydraulický filter umiestnený v nádrži - sací kôš, 125 mikrónov, priemer závitů 71,5 mm, výška 320 mm



332/B1918

**JCB**



**Filter** vložka hydraulického filtra, 18 mikrónov, výška 230 mm, priemer 60 mm



32/925346

**JCB**



**Puzdro** konzoly spojovacej tyče, rozmer 25x30x33 mm



808/00253

**JCB**



**Čap** priečného tiahla riadenia, dĺžka 95 mm



911/22800

**JCB**



**Brzdová lamela** zadnej nápravy, JCB 3CX, 4CX, priemer 222 mm



458/20353

**JCB**



**Svetlomet** univerzálny hlavný svetlomet so smerovkou, napätie 12V



700/50121/P

**JCB**



**Termostat** chladiaceho systému, otváracia teplota 82°C



02/202107

**JCB**



**Termostat** chladiaceho systému pre motor JCB DieselMax, otváracia teplota 88°C



320/04552

**JCB**



**Tesniaci krúžok** vstrekovacieho ventilu, rozmer 32,8x16,83x9,36 mm



320/07504

**JCB**



**Uloženie motora** silentblok motora JCB



246/01107

**JCB**



**Napínacia kladka remeňa** pre motor JCB 444



320/A8586

**JCB**



**Snímač** tlaku oleja JCB



701/60040

**JCB**



**Snímač** uhlu natočenia volantu JCB



716/D2286

**JCB**



**Elektromagnetický ventil** radenia prevodovky, priemer cievky 22 mm



25/222913



**Čap riadenia** JOHN DEERE, dĺžka 180 mm, vnútorný závit M24X1.5 mm, vonkajší závit M20x1.5 mm



AL204776-JD



**Čap riadenia** kompletná tyč riadenia JOHN DEERE



AL204774-JD



**Kardanový kríž** kardanový kríž JOHN DEERE, dĺžka 106,2 mm



RE37355-JD



**Ventil** čerpadla prevodovky JOHN DEERE



RE190713-JD



**Ložisko** prevodovky JOHN DEERE, 97x77x50 mm



JD9932-JD



**Torzny tlmáč** JOHN DEERE



RE586976-JD



**Tesnenie** hlavy valcov JOHN DEERE, motor YANMAR 4TNV84T



MIU800384-JD

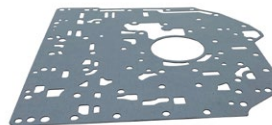

**Tesnenie** skrine prevodovky



R127580-JD



**Tesnenie** veka ventilov, motor JOHN DEERE 6068H



R524496-JD



**Relé** univerzálne relé JOHN DEERE, 5 pin



AL77324-JD



**Relé** univerzálne relé JOHN DEERE, 4 pin



AL152098-JD



**Relé** štartovacie relé JOHN DEERE, 12V, 100Amp



RE164448-JD



**Spínač** zapojenia prednej nápravy



AL114044-JD



**Spínač** výstražných svetiel



AL32062-JD



**Spínač** zapalovania



RE56411-JD



## PONUKA PNEUMATÍK

**Firestone**



**Agro pneumatika** rozmer 380-70 R24, dezén PERFORMER 70



**380-70R24 RFR PERF70**

**Firestone**



**Agro pneumatika** rozmer 380-85 R24, dezén PERFORMER 85



**380-85R24 RFR PERF85**

**Firestone**



**Agro pneumatika** rozmer 440-65 R28, dezén MAXI TRACTION 65



**440-65R28 RFR MAXTR65**

**BRIDGESTONE**



**Agro pneumatika** rozmer 650-65 R38, dezén VX-TRACTOR



**650-65R38 RBR VXTRAC**

**BRIDGESTONE**



**Agro pneumatika** rozmer 600-65 R38, dezén VX-TRACTOR



**600-65R38 RBR VXTRAC**

**BRIDGESTONE**



**Agro pneumatika** rozmer 360-70 R24, dezén VX-TRACTOR



**360-70R24 RBR VXTRAC**

**BKT**



**Agro pneumatika** rozmer 16.5x6.50 - 8, 6 plátňová pneu, dezén LG306



**166508 OQBK LG306**

**BKT**



**Agro pneumatika** rozmer 7.50 - 16, 8 plátňová pneu, dezén AS 504



**7.50-16 AS504 8PR**

**BKT**



**Agro pneumatika** rozmer 10.0-75 - 15.3, 18 plátňová pneu, dezén AS 504



**10.0-75-15.3 RBK AS504 18**

**AGSTAR**



**Agro pneumatika** rozmer 6.00 - 16, 8 plátňová pneu, dezén 1630



**6.00-16 RAG 1630 8PR**

**AGSTAR**



**Agro pneumatika** rozmer 7.50 - 18, 8 plátňová pneu, dezén 1630



**7.50-18 RAG 1630 8PR**

**AGSTAR**



**Agro pneumatika** rozmer 4.00 - 16, 6 plátňová pneu, dezén 1630



**4.00-16 RAG 1630 6PR**

**LINGLONG TIRE**



**Priemyselná pneumatika** rozmer 460-70 R24, dezén LR451



**460-70R24 PLL LR451XL**

**LINGLONG TIRE**



**Agro pneumatika** rozmer 650-55 R26.5, dezén FL300



**650-55R26.5 RLL FL300**

**LINGLONG TIRE**



**Agro pneumatika** rozmer 340-85 R36, dezén LR861



**340-85R36 RLL LR861**



INTER  
CARS

ORIENTUJTE SA LEPŠIE  
V NAŠOM KATALÓGU

# NEPREHLIADNITE PONUKU PNEUMATÍK PRE PRIEMYSELNÉ A POĽNOHOSPODÁRSKE STROJE

V ponuke nájdete pneumatiky rôznych svetových značiek v rôznych triedach kvality s doručením do 3 – 5 pracovných dní

1. V hlavnom menu kliknite na ponuku "Pneumatiky"

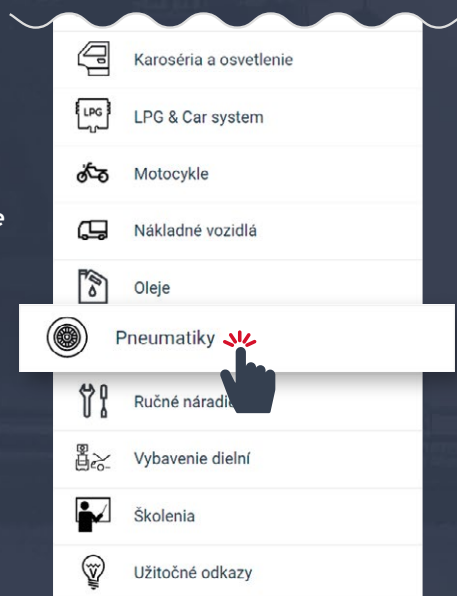

2. Na zobrazenom filtri vyhládajte a aktivujte podmenu "Zmena" a tam kliknite na "Priemyselné a poľnohospodárske pneumatiky"

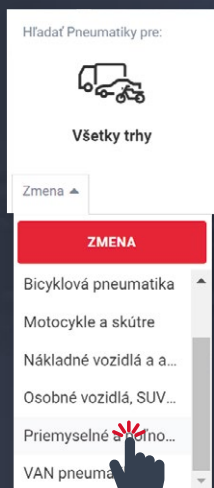

3. Po zaflirtovaní pneumatík pre AGRO a PRACOVNÉ STROJE filtrujete konkrétne parametre pneumatík, o aké máte záujem

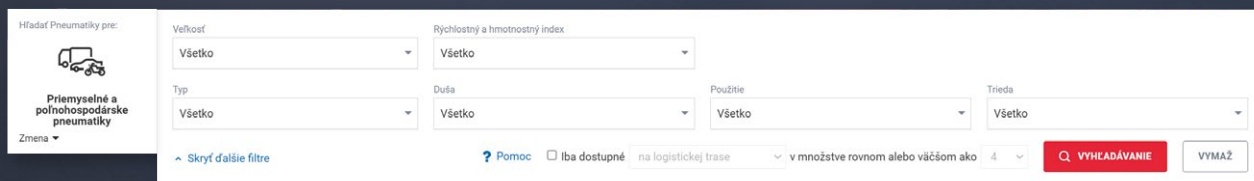

AGSTAR

BKT  
GROWING TOGETHER

BRIDGESTONE

Continental

MICHELIN

LINGLONG TIRE

VÝHODNÉ PONUKY NÁJDETE V E-CAT KATALÓGU

WWW.INTERCARS.SK



# Príslušenstvo

V ponuke Inter Cars nájdete široký sortiment príslušenstva pre poľnohospodárske traktory, ako sú zrkadlá, stierače, vybavenie kabíny, reflektory, pozičné svetla, plynové vzpery kapoty a mnohé iné. Máme len produkty od overených, kvalitných výrobcov. Rozmanitosť nášho sortimentu vám umožní vybrať si to správne príslušenstvo pre váš stroj. Vďaka našim produktom si prispôbite vozidlo svojim potrebám a zabezpečíte si patričný komfort a bezpečnosť používania.



ADVANCED TECHNOLOGY  
**AGNUM**

**Cargoparts**

**WESEM**



**RYWAL**



**Stierač** kĺbový, dĺžka 400.0 mm, CASE, FIAT



**9XW204 163-161**



**Stierač** kĺbový, dĺžka 450.0 mm, FENDT



**9XW204 163-181**



**Stierač** kĺbový, dĺžka 500.0 mm, MERCEDES, FENDT, DEUTZ



**9XW204 163-201**



**Stierač** kĺbový, dĺžka 550.0 mm, FENDT, CASE, CLAAS, NEW HOLLAND



**9XW204 163-221**



**Stierač** kĺbový, dĺžka 600.0 mm, JCB, JOHN DEERE, LANDINI, MASSEY FERGUSON



**9XW204 163-241**



**Odrážka** farba biela, šírka 32.0 mm, výška 69.0 mm, hrúbka 6.0 mm, spôsob montáže samolepiaca, CASE, LIEBHERR



**8RA004 412-011**



**Odrážka** farba červená, šírka 40.0 mm, výška 180.0 mm, hrúbka 5.0 mm, spôsob montáže skrutkovací, FENDT, DEUTZ



**8RA002 023-001**

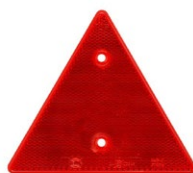

**Odrážka** farba červená, šírka 136.0 mm, výška 156.0 mm, hrúbka 8.0 mm, spôsob montáže skrutkovací, AGCO, CASE, CLAAS



**8RA002 020-001**



**Odrážka** farba červená, priemer 95.0 mm, spôsob montáže skrutkovací, BOMAG, CASE, CATERPILLAR



**8RA002 016-121**



**Interiérové svetlo**, dĺžka 175.0 mm, hĺbka 37.0 mm, výška 175.0 mm, farba priehľadná / šedá, KRAMER



2JA005 590-001



**Interiérové svetlo**, dĺžka 165.0 mm, šírka 35.0 mm, výška 25.0 mm, farba biela mliečna, AGCO, CASE, CATERPILLAR



2JA001 330-001



**Interiérové svetlo**, dĺžka 92.0 mm, šírka 11.0 mm, výška: 47.0 mm, farba priehľadná / čierna, BOMAG



2JA343 570-011



**Obrysové svetlo** farba biela, šírka 84.0 mm, výška 51.0 mm, hĺbka 84.0 mm, AGCO, CASE, CLAAS



2PF003 014-071



**Obrysové svetlo** farba oranžová, šírka 102.0 mm, výška 13.0 mm, hĺbka: 45.0 mm, UNIVERZÁL AGRO



2PS964 295-061



**Obrysové svetlo** farba priehľadná, šírka 70.0 mm, výška 36.0 mm, hĺbka 37.0 mm, UNIVERZÁL AGRO



2PF997 022-011



**Pracovný svetlomet** farba skla priehľadná, typ žiarovky H3, výška 113.0 mm, šírka 83.0 mm, hĺbka 76.0 mm, JOHN DEERE, LIEBHERR



1G0996 176-001



**Pracovný svetlomet** farba skla priehľadná, typ žiarovky H9, dĺžka 85.0 mm, výška 95.0 mm, šírka 85.0 mm, AGCO, CASE, CLAAS, DEUTZ, FENDT



1G0996 176-061



**Pracovný svetlomet** farba skla priehľadná, typ žiarovky HB3, výška 122.0 mm, šírka 174.0 mm, hĺbka 120.0 mm, CASE, JOHN DEERE



1GB996 186-051



**Otočný maják** farba oranžová, typ žiarovky H1, výška 173.0 mm, priemer 137.0 mm, UNIVERZÁL AGRO



2RL007 550-001



**Otočný maják** farba oranžová, typ žiarovky H1, výška 172.0 mm, priemer 136.0 mm, UNIVERZÁL AGRO



2RL007 552-001



**Držiak otočného majáku** priemer 24.0 mm, dĺžka 1000.0 mm, UNIVERZÁL AGRO



8HG006 294-041



**Zadná hmlovka** farba skla červená, typ žiarovky P21W, výška 45.0 mm, dĺžka 106.0 mm, UNIVERZÁL AGRO



2NE006 609-001



**Zadná hmlovka** farba skla červená, typ žiarovky P21W, výška 74.0 mm, dĺžka 124.0 mm, UNIVERZÁL AGRO



2NE002 985-001



**Zadná hmlovka** farba skla červená, typ žiarovky P21W, výška 90.0 mm, dĺžka 80.0 mm, UNIVERZÁL AGRO



2NE996 012-021



## PRÍSLUŠENSTVO



**Zadné svetlo** farba skla červená/oranžová/biela, typ žiarovky P21W/R5W, výška 51.0 mm, šírka 98.0 mm, MASSEY FERGUSON, VOLVO



2SE998 530-061



**Zadné svetlo** farba skla červená/oranžová/biela, typ žiarovky P21W/R10W, výška 64.0 mm, dĺžka 158.0 mm, DEUTZ



2SE997 111-011



**Zadné svetlo** farba skla červená/oranžová, typ žiarovky P21W/R5W, výška 80.0 mm, priemer 140.0 mm, UNIVERZÁL AGRO



2SE001 685-221



**Zadné svetlo** farba skla biela/oranžová, typ žiarovky P21W, výška 82.5 mm, priemer 122.5 mm, CLAAS, CASE, CATERPILLAR



2BN964 169-057



**Zadné svetlo** farba skla biela, typ žiarovky LED, hrúbka 38.90 mm, vonkajší priemer 112.30 mm, vnútorný priemer 67.0 mm, DEUTZ, LANDINI



2SB009 362-021



**Zadné svetlo** farba svetla červená/biela/oranžová, typ žiarovky LED, výška 130.0 mm, dĺžka 300.0 mm, UNIVERZÁL



2VP345 900-141



**Hlavný svetlomiet** typ žiarovky H4, výška 107.0 mm, šírka 167.0 mm, CASE, CATERPILLAR



1AB003 177-001



**Hlavný svetlomiet** typ žiarovky HB3, dĺžka 157.10 mm, priemer 88.50 mm, CLAAS, LINDNER



1BL998 570-001



**Hlavný svetlomiet** typ žiarovky H4/T4W, výška 162.0 mm, šírka 207.0 mm, UNIVERZÁL AGRO



1AB996 157-151



**Hlavný svetlomiet** typ žiarovky H4/T4W, výška 102.0 mm, šírka 182.0 mm, UNIVERZÁL AGRO



1AD996 018-641



**Hlavný svetlomiet** typ žiarovky H4, výška 107.0 mm, šírka 130.0 mm, FENDT



1AB008 888-051



**Hlavný svetlomiet** typ žiarovky H7/H3/P21W/T4W, výška 212.0 mm, šírka 150.0 mm, UNIVERZÁL AGRO



1SA996 120-471



**Hlavný svetlomiet** typ žiarovky H3/H7/T4W, výška 140.0 mm, šírka 140.0 mm, MANITOU



1SA990 185-101



**Hlavný svetlomiet** typ žiarovky H4/T4W, výška 106.0 mm, šírka 167.0 mm, AGCO, FENDT



1AB006 277-127



**Hlavný svetlomiet** typ žiarovky H4, výška 107.0 mm, šírka 167.0 mm, JOHN DEERE



1AB006 977-021





Cargo parts



**Reflexná nálepka** typ 30 km/h, priemer 200,0 mm, povrch reflexný



CARGO-T040

Cargo parts



**Reflexná nálepka** typ 40 km/h, priemer 200,0 mm, povrch reflexný



CARGO-T020

Cargo parts



**Reflexná nálepka** typ 60 km/h, priemer 200,0 mm, povrch reflexný



CARGO-T005

Cargo parts



**Výstražný trojuholník** výstražný trojuholník pre pomaly idúce vozidla, reflexný, tabuľa



CARGO-T034

Cargo parts



**Výstražný trojuholník** výstražný trojuholník pre pomaly idúce vozidla, reflexný, nálepka



CARGO-T113

Cargo parts



**Výstražná tabuľa** výstražná tabuľa pre nadrozmetný náklad, s červeným svetlom, rozmer 300 mm x 400 mm



CARGO-T004

Cargo parts



**Upínací popruh** dĺžka 3.0 m, ťahová sila STF 40.0 daN



PK03M-02-0.4T

Cargo parts



**Upínací popruh** dĺžka 8.0 m, ťahová sila STF 300.0 daN



PK08M-01-4T

Cargo parts



**Upínací popruh** dĺžka 10.0 m, ťahová sila STF 300.0 daN



PK10M-01-4T

Cargo parts



**Kotviaca reťaz** pre upevnenie nákladu, dĺžka 5.0 m, priemer reťaze 8.0 mm, upínacia sila 40.0 kN



GM-LO-G8 F18 5000

Cargo parts



**Kotviaca reťaz** pre upevnenie nákladu, dĺžka 3.5 m, priemer reťaze 10.0 mm, upínacia sila 63.0 kN



GM-LO-G8 F110 3500

Cargo parts



**Kotviaca reťaz** pre upevnenie nákladu, dĺžka 5.0 m, priemer reťaze 13.0 mm, upínacia sila 100.0 kN



GM-LO-G8 F113 5000

Cargo parts



**Napínač reťaze:** račňový napínač na upevnenie nákladu, priemer reťaze 10.0 mm, upínacia sila 63.0 kN



GM-BNT 10MM

Cargo parts



**Kotviaca reťaz sada** kotviaca reťaz s račňou na upevnenie nákladu, jednodielna, dĺžka 5.0 m, priemer reťaze 8.0 mm, upínacia sila 40.0 kN



GM-OJ-G8 F18 5000

Cargo parts



**Kotviaca reťaz sada** kotviaca reťaz s račňou na upevnenie nákladu, dvojdielna, dĺžka 5.0 m, priemer reťaze 10.0 mm, upínacia sila 63.0 kN



GM-O-G8 F110 5000



## PRÍSLUŠENSTVO

.11cgnum



**Plynová vzpera** výtlačná sila 150.0 N, max. dĺžka 256.0 mm, UNIVERZÁL



MGS131

.11cgnum



**Plynová vzpera** výtlačná sila 180.0 N, max. dĺžka 250.0 mm, UNIVERZÁL



MGS159

.11cgnum



**Plynová vzpera** výtlačná sila 410.0 N, max. dĺžka 215.0 mm, UNIVERZÁL



MGS060

.11cgnum



**Plynová vzpera** výtlačná sila 330.0 N, ax. dĺžka 410.0 mm, UNIVERZÁL



MGS100

.11cgnum



**Plynová vzpera** výtlačná sila 400.0 N, max. dĺžka 245.0 mm, UNIVERZÁL



MGS101

.11cgnum



**Plynová vzpera** výtlačná sila 200.0 N, max. dĺžka 340.0 mm, UNIVERZÁL



MGS104

.11cgnum



**Plynová vzpera** výtlačná sila 670.0 N, max. dĺžka 384.5 mm, UNIVERZÁL



MGS116

.11cgnum



**Plynová vzpera** výtlačná sila 750.0 N, max. dĺžka 250.0 mm, UNIVERZÁL



MGS140

.11cgnum



**Plynová vzpera** výtlačná sila 300.0 N, max. dĺžka 252.0 mm, UNIVERZÁL



MGS156

.11cgnum



**Plynová vzpera** výtlačná sila 700.0 N, max. dĺžka 440.0 mm, UNIVERZÁL



MGS075

.11cgnum



**Plynová vzpera** výtlačná sila 400.0 N, max. dĺžka 385.0 mm, UNIVERZÁL



MGS107

.11cgnum



**Plynová vzpera** výtlačná sila 520.0 N, max. dĺžka 280.0 mm, UNIVERZÁL



MGS150

.11cgnum



**Plynová vzpera** výtlačná sila 650.0 N, max. dĺžka 785.0 mm, UNIVERZÁL



MGS211

.11cgnum



**Plynová vzpera** výtlačná sila 100.0 N, max. dĺžka 500.0 mm, UNIVERZÁL



MGS094

.11cgnum



**Plynová vzpera** výtlačná sila 140.0 N, max. dĺžka 540.0 mm, UNIVERZÁL



MGS139



**Plynová vzpera** výtlačná sila 100.0 N, max. dĺžka 276.0 mm, priemer piestnice 6.0 mm, priemer valca: 15.0 mm, UNIVERZÁL



**KR21496**



**Plynová vzpera** výtlačná sila 250.0 N, max. dĺžka 300.0 mm, priemer piestnice 8.0 mm, priemer valca 18.5 mm, UNIVERZÁL



**KR23490**



**Plynová vzpera** výtlačná sila 500.0 N, max. dĺžka 585.0 mm, priemer piestnice 8.0 mm, priemer valca 19.0 mm, UNIVERZÁL



**KR31124**



**Plynová vzpera** výtlačná sila 130.0 N, max. dĺžka 248.0 mm, priemer piestnice 8.0 mm, priemer valca 18.5 mm, UNIVERZÁL



**KR21681**



**Plynová vzpera** výtlačná sila: 400.0 N, max. dĺžka 352.0 mm, priemer piestnice 8.0 mm, priemer valca 19.0 mm, UNIVERZÁL



**KR21088**



**Plynová vzpera** výtlačná sila 200.0 N, max. dĺžka 373.0 mm, priemer piestnice 8.0 mm, priemer valca 18.5 mm, UNIVERZÁL



**KR32072**



**Plynová vzpera** výtlačná sila 400.0 N, max. dĺžka 245.0 mm, priemer piestnice 6.0 mm, priemer valca 15.0 mm, UNIVERZÁL



**KR31410**



**Plynová vzpera** výtlačná sila 50.0 N, max. dĺžka 155.5 mm, priemer piestnice 6.0 mm, priemer valca 15.0 mm, UNIVERZÁL



**KR32248**



**Plynová vzpera** výtlačná sila 180.0 N, max. dĺžka 500.0 mm, priemer piestnice 8.0 mm, priemer valca 19.0 mm, UNIVERZÁL



**KR21475**



**Plynová vzpera** výtlačná sila 320.0 N, max. dĺžka 500.0 mm, priemer piestnice 8.0 mm, priemer valca 18.5 mm, UNIVERZÁL



**KR21928**



**Plynová vzpera** výtlačná sila 500.0 N, max. dĺžka 560.0 mm, priemer piestnice 8.0 mm, priemer valca 18.5 mm, UNIVERZÁL



**KR23049**



**Plynová vzpera** výtlačná sila 280.0 N, max. dĺžka 305.0 mm, priemer piestnice 8.0 mm, priemer valca 19.0 mm, UNIVERZÁL



**KR23724**



**Plynová vzpera** výtlačná sila 350.0 N, max. dĺžka 240.0 mm, priemer piestnice 8.0 mm, priemer valca 19.0 mm, UNIVERZÁL



**KR23744**



**Plynová vzpera** výtlačná sila 280.0 N, max. dĺžka 500.0 mm, priemer piestnice 8.0 mm, priemer valca 19.0 mm, UNIVERZÁL



**KR23758**



**Plynová vzpera** výtlačná sila 200.0 N, max. dĺžka 480.0 mm, priemer piestnice 8.0 mm, priemer valca 18.5 mm, UNIVERZÁL



**KR24647**



## PRÍSLUŠENSTVO

WESEM ●



**Pracovný svetlomet** typ žiarovky LED, výkon 40.0 W, počet lumenov 4000.0 lm, dĺžka 176.0 mm, výška 87.0 mm, hĺbka 86.0 mm



CRVIB.52302.01

WESEM ●



**Pracovný svetlomet** typ žiarovky LED, výkon 24.0 W, počet lumenov 1500.0 lm, hĺbka 74.0 mm, priemer 117.0 mm



CRC3B.49200.02

WESEM ●



**Pracovný svetlomet** typ žiarovky LED, výkon 35.0 W, počet lumenov 3000.0 lm, dĺžka 176.0 mm, výška 87.0 mm, hĺbka 86.0 mm



CRVIM.53501.00

WESEM ●



**Pracovný svetlomet** typ žiarovky LED, výkon 21.0 W, počet lumenov 2000.0 lm, hĺbka 72.0 mm, priemer 87.0 mm



CRCSH.53378.02

WESEM ●



**Pracovný svetlomet** typ žiarovky LED, výkon 28.0 W, počet lumenov 2200.0 lm, dĺžka 176.0 mm, výška 87.0 mm, hĺbka 86.0 mm



CRVIC.52702

WESEM ●



**Pracovný svetlomet** typ žiarovky LED, výkon 35.0 W, počet lumenov 3000.0 lm, dĺžka 176.0 mm, výška 87.0 mm, hĺbka 86.0 mm



CRVIA.49501.01

WESEM ●



**Hlavný svetlomet** typ žiarovky H4, typ ovládania manuálny, farba vnútra chromovaná



RE.25677.01

WESEM ●



**Hlavný svetlomet** typ žiarovky R2/T4W, farba vnútra chromovaná



RGP2.52660.02

WESEM ●



**Hlavný svetlomet** typ žiarovky H4, farba vnútra chromovaná



RE.27096.00

WESEM ●



**Zadné svetlo** farba skla červená / žltá, s držiakom žiarovky



LT4.52100.01

WESEM ●



**Zadné svetlo** farba skla červená / žltá, s držiakom žiarovky



LT2.26600.01

WESEM ●



**Zadné svetlo** farba skla červená / žltá, s držiakom žiarovky



LT3.48400.01

WESEM ●



**Osvetlenie ŠPZ** farba skla priesvitná, typ žiarovka



LSP1.48500.01

WESEM ●



**Objímka žiarovky H4**



A.07128.02

WESEM ●



**Smerovka** farba skla biela / oranžová, s držiakom žiarovky



LT3.48460.01



# Pracovné a doplnkové svetlá

## OSRAM



Kedykoľvek je potrebné osvetliť veľké plochy, svetlá LEDriving od spoločnosti Osram môžu používatelia využiť najmä pre ich vysoký svetelný výkon a vynikajúcu viditeľnosť vďaka efektu denného svetla. Kompaktné a robustné polykarbonátové šošovky odolávajú aj vysokej záťaži. Svetlá sú vďaka tomu vhodné na použitie pri jazde po ceste aj v teréne pre osobné aj nákladné vozidlá, vozidlá SUV a dokonca aj pracovné vozidlá.

Pracovné svetlá LED ponúkajú rôzne funkcie osvetlenia a sú chránené pred nesprávnou polaritou. Doplnkové svetlá LED sú k dispozícii v troch produktových radoch, ktoré sa líšia výkonom, tvarom a uhlom lúča.

Pracovné a doplnkové svetlá LEDriving od spoločnosti Osram sa vyznačujú svetelným výkonom až 5 500 lm a dosvitom až 450m. V priebehu dňa dodávajú vozidlám jedinečný vzhľad vďaka štýlovému a homogénnemu akcentovanému osvetleniu. V noci a v zlých svetelných podmienkach poskytujú ideálne osvetlenie pre široký rozsah použitia. Inteligentný dizajn reflektorov s nepriamym osvetlením vedie k jednotnej distribúcii svetla a zníženiu odleskov pre protiľadúce vozidlá. Svetlá majú teplotu chromatickosti podobnú dennému svetlu s hodnotou 6000 K a majú päťročnú záruku. Podľa konkrétnej krajiny môže byť vyžadované, aby boli čelné svetlá inštalované v pároch. To platí aj pre Slovensko s výnimkou svetla LED-DLI04-CB SM, kde je možná inštalácia jedného svetla. Doplnkové svetlá LED spĺňajú všetky podmienky schválenia EHK, môžu byť preto používané na

verejných komunikáciách. Dlhá životnosť dosahujúca až 10 000 hodín je zaistená vďaka ochrane 12/24V poistkou a integrovanému riadiacemu a chlaďacemu systému.

### Modernizované osvetlenie s vysokou intenzitou: Pracovné svetlá LEDriving

Nový rad pracovných svetiel Multifunctional zahŕňa produkty s niekoľkými funkciami osvetlenia, ktoré vylepšujú osvetlenie vozidla. Úplná ochrana polarizácie zabráňuje možnému poškodeniu elektronických súčiastok v prípade nesprávnej polarizácie. Produkty Cube MX85-SP a MX85-WD sú vybavené štyrmi výkonnými LED s dvoma funkciami: pracovné svetlo a štýlové svetlo v tvare X. MX85-SP ponúka diaľkové osvetlenie o šírke 110 m, zatiaľ čo Cube MX85-WD je vhodné najmä na osvetlenie krátkych vzdialeností a ponúka osvetlenie so šírkou 55m.

### Široký rozsah pre lepšie osvetlenie na ceste: Jazdné svetlá LEDriving

Nový produktový rad poskytuje ideálnu optickú účinnosť na ceste s využi-

tím nepriameho svetla vďaka inteligentnému dizajnu reflektorov. Tieto doplnkové svetlá majú EHK schválenie, je možné ich v súlade s legislatívou používať na verejných komunikáciách (pri dodržaní pokynov pre montáž). Doplnkové svetlá LEDriving sú k dispozícii v rôznych radoch: Rad Functional zahŕňa produkty s jedinou funkciou osvetlenia. Verzia FX250-SP osvetľuje vďaka desiat LED diódam cestu do vzdialenosti až 360 m a má 5° uhol lúča vhodný pre veľké vzdialenosti. FX250-CB ponúka kombinované osvetlenie pre krátke a dlhé vzdialenosti. Rad Slim sa vyznačuje natoľko kompaktnými rozmermi, že je možné modely tohto radu nainštalovať na mnoho rôznych miest vo vozidle.

Tieto produkty umožňujú prevádzku vo veľmi širokom rozsahu teplôt od -30 °C do +60 °C. Produkt SX300-SP napríklad osvetľuje vzdialenosť až 270 m pri výkone 2600 lm vďaka použitiu 12 LED. Produkt Lightbar SX500-SP vybavený 18 LED ponúka výkon až 3 900 lm na vzdialenosť 370 m a predstavuje najvýkonnejší produkt v tomto rade. Menovitý príkon svetla je 46 W.



## PRÍSLUŠENSTVO



**Pracovný svetlomiet** typ žiarovky LED, výkon 20.0 W, počet lumenov 2000.0 lm, hĺbka 46.0 mm, priemer 108.0 mm



1216 W163



**Pracovný svetlomiet** typ žiarovky LED, výkon 55.0 W, počet lumenov 7000.0 lm, dĺžka 110.0 mm, výška 110.0 mm, hĺbka 85.3 mm



1207/II W130



**Pracovný svetlomiet** typ žiarovky LED, výkon 68.0 W, počet lumenov 7000.0 lm, dĺžka 150.0 mm, výška 131.0 mm, hĺbka 44.0 mm



1157 W164



**Odrážka farba biela**



71B



**Odrážka farba červená**



71CZ



**Odrážka farba oranžová**



71P



**Osvetlenie ŠPZ** typ žiarovky LED, farba červená



409 W72



**Osvetlenie ŠPZ** typ žiarovky LED, farba čierna



408 W72



**Osvetlenie ŠPZ** typ žiarovky LED, farba čierna



244 W52



**Obrysovú svetlo** farba biela, typ žiarovky LED, šírka 106.5 mm, výška 46.5 mm, hĺbka 21.8 mm



1385 W196



**Obrysovú svetlo** farba oranžová, typ žiarovky LED, šírka 106.5 mm, výška 46.5 mm, hĺbka 21.8 mm



1383 W196



**Obrysovú svetlo** farba biela, typ žiarovky LED, šírka 119.0 mm, výška 44.0 mm, hĺbka 19.5 mm



1414 W201



**Zadné svetlo** montážna strana pravá / ľavá, farba smerového svetla oranžová, farba skla červená



03 WE-549L



**Zadné svetlo** montážna strana pravá / ľavá, typ žiarovky LED,



1429 L/P W206



**Zadné svetlo** montážna strana pravá / ľavá, typ žiarovky LED, dynamický ukazovateľ



1432 DD L/P W205DD



**Spätne zrkadlo** dĺžka 236.0 mm, šírka 180.0 mm, UNIVERZÁL



LP 0236



**Spätne zrkadlo** dĺžka 263.0 mm, šírka 160.0 mm, UNIVERZÁL



LP0263



**Spätne zrkadlo** dĺžka 410.0 mm, šírka 220.0 mm, UNIVERZÁL



LS 0305



**Spätne zrkadlo** dĺžka 290.0 mm, šírka 175.0 mm, UNIVERZÁL



LRLDT285



**Spätne zrkadlo** dĺžka 310.0 mm, šírka 205.0 mm, UNIVERZÁL



LS 0310



**Spätne zrkadlo** dĺžka 295.0 mm, šírka 215.0 mm, UNIVERZÁL



LP0295



**Spätne zrkadlo** dĺžka 314.0 mm, šírka 228.0 mm, UNIVERZÁL



LP0314



**Spätne zrkadlo** dĺžka 320.0 mm, šírka 170.0 mm, vyhrievané, UNIVERZÁL



LS 0320 E



**Spätne zrkadlo** dĺžka 328.0 mm, šírka 238.0 mm, UNIVERZÁL



LP0328



**Spätne zrkadlo** dĺžka 250.0 mm, šírka 165.0 mm, s držiakom, UNIVERZÁL



KWL 01



**Spätne zrkadlo** dĺžka 305.0 mm, šírka 170.0 mm, s držiakom, UNIVERZÁL



KWL 06



**Spätne zrkadlo** dĺžka 285.0 mm, šírka 155.0 mm, s držiakom, UNIVERZÁL



KWL 02



**Spätne zrkadlo** dĺžka 305.0 mm, šírka 170.0 mm, s držiakom, UNIVERZÁL



KWL 08



**Spätne zrkadlo** dĺžka 285.0 mm, šírka 155.0 mm, s držiakom, UNIVERZÁL



KWL 07



**Spätne zrkadlo** dĺžka 305.0 mm, šírka 170.0 mm, s držiakom, UNIVERZÁL



KWL 04



## PRÍSLUŠENSTVO



**Spätné zrkadlo** dĺžka 375.0 mm, šírka 185.0 mm, DEUTZ, NEW HOLLAND, SAME



5667025-SN



**Držiak spätného zrkadla** montážna strana ľavá, dĺžka 200.0 mm, priemer 20.0 mm, DEUTZ, SAME



6591031-SN



**Držiak spätného zrkadla** montážna strana pravá, dĺžka 200.0 mm, priemer 20.0 mm, DEUTZ, SAME



6490030-SN



**Spätné zrkadlo** montážna strana pravá/ľavá, dĺžka 246.0 mm, šírka 182.0 mm, DEUTZ, MASSEY FERGUSON, SAME



6411000-SN  
6411001-SN



**Spätné zrkadlo** montážna strana pravá/ľavá, dĺžka 245.0 mm, šírka 180.0 mm, DEUTZ, SAME



6593000-SN  
6593001-SN



**Spätné zrkadlo** montážna strana pravá/ľavá, dĺžka 235.0 mm, šírka 180.0 mm, NEW HOLLAND



6593000-SN  
6476001-SN



**Spätné zrkadlo** montážna strana pravá/ľavá, dĺžka 236.0 mm, šírka 180.0 mm, MASSEY FERGUSON, SAME



6490000-SN  
6490001-SN



**Spätné zrkadlo** montážna strana pravá/ľavá, dĺžka 235.0 mm, šírka 180.0 mm, MASSEY FERGUSON, SAME



6590000-SN  
6590001-SN



**Spätné zrkadlo** montážna strana pravá/ľavá, dĺžka 236.0 mm, šírka 180.0 mm, NEW HOLLAND



6597000-SN  
6597001-SN



**Spätné zrkadlo** montážna strana pravá/ľavá, dĺžka 235.0 mm, šírka 140.0 mm, DEUTZ, SAME



6591000-SN  
6591001-SN



**Spätné zrkadlo** montážna strana pravá/ľavá, dĺžka 245.0 mm, šírka 155.0 mm, CLAAS



6560000-SN  
6560001-SN



**Spätné zrkadlo** montážna strana pravá/ľavá, dĺžka 235.0 mm, šírka 180.0 mm, DEUTZ, SAME



6395000-SN  
6395001-SN



**Spätné zrkadlo** montážna strana pravá/ľavá, dĺžka 310.0 mm, šírka 180.0 mm, DEUTZ, SAME



6428000-SN  
6428001-SN



**Spätné zrkadlo** montážna strana pravá/ľavá, dĺžka 375.0 mm, šírka 187.0 mm, SAME



6396000-SN  
6396001-SN



**Spätné zrkadlo** montážna strana pravá/ľavá, dĺžka 420.0 mm, šírka 200.0 mm, CLAAS



6400000-SN  
6400001-SN





# Ponuka vybavenia dielní pre AGRO

## EVERT



### Kompresor skrutkový EVERT séria X, 7,5 kW 400V 10 bar

- Napätie: 400,0 V
- Účinnosť: 970,0 l/min.
- Nádrž: 500,0 l
- Sušič: Áno
- Tlak: 10,0 bar
- Typ závitů: 3/4
- Hlučnosť: 63,0 dB
- Menovitý výkon: 7,5 kW
- Váha: 418 kg

EVERT-X7,5/500/D

## BOSCH



### AUTOMATICKÁ PLNIČKA KLIMATIZÁCIÍ ACS 810

- Zariadenie vhodné pre nákladné automobily a autobusy
- Chladivo: R-134a
- Interný zásobník chladiva: 35 kg
- Databáza vozidiel: osobné, úžitkové a nákladné
- Obsluha hybridných vozidiel: NIE
- Výkon vakuovej pumpy: 283 l
- Dĺžka hadíc: 5 m
- Automatické ventily: NIE
- Elektronická váha na olej: ÁNO
- Aretácia váhy pri transporte: NIE
- Tlačiareň: ÁNO
- Rozmery (DxŠxV): 690 x 660 x 1270 mm

S P00 000 003

## Chladivo



R-1234yf - 5 kg

R1234YF/5+ BUTLA



R-134a - 12 kg:

R134A/12+ BUTLA

## KÄRCHER



### KÄRCHER PUZZI 10/1

- Tepovač PuZZi 10/1 s podlahovou hubicou a hubicou na čalúnenie.
- Max. plošný výkon: 20 – 25 m<sup>2</sup>/h
- Prietok vzduchu: 74 l/s
- Objem nástreku: 1 l/min
- Nádrž na vodu 10 l/9 l

1.100-130.0

## KÄRCHER



### KÄRCHER NT 30/1 Ap L

- Kompaktný mokrý-suchý vysávač s vynikajúcim sacím výkonom.
- Prietok vzduchu: 74 l/s
- Vákuum: 273 / 27,3 mbar / kPa
- Objem nádoby: 30 l
- Prikonmax. 1380 W"

1.148-221.0

## KÄRCHER



### KÄRCHER HDS 5/15 UX

- Horúcovodný vysokotlakový čistič s hadicovým bubnom a 15 m hadicou.
- Prietok: 450 l/h
- Pracovný tlak: 150 / 15 bar / MPa
- Prikon: 2,7 kW
- Teplota: max 80°C

1.064-913.0

## atas



### Dvojjložková aktívna pena na silné znečistenia

Je určená pre automobily, kamióny, návesy, návesové plachty, motory, atď. Služi na odmasťovanie a čistenie všetkých druhov nečistôt (tukov, smogu, špiny, škvrn od krvi, zvyškov ropných látok).

DIMER 10KG

## KÄRCHER



### FLOORPRO INTENZÍVNY ČISTIČ EXTRA RM 752, 10l

Extra silný základný čistič na odstraňovanie silného znečistenia a povrchových vrstiev z podláh odolným voči alkáliám (olej, masť, kálie).

6.295-813.0

## KÄRCHER



### CARPETPRO RM 760 PRAŠOK, 10 KG

Prášok na hĺbkové čistenie tepovaním. Odstraňuje aj ťažký olej, masť a minerálne nečistoty z textilných podlahových krytín a zanecháva príjemnú, sviežu vôňu.

6.294-844.0



## VYBAVENIE DIELNÍ

### EVERT



#### Vyzúvačka pneumatík pre TRUCK a AGRO stroje

► výkonný el. motor a hydraulický systém pre silný ťah a držanie kolesa, ► výkon pumpy 1,5 kW, 400V, motor 2,4kW, ► pracovný tlak 130-150 bar, vstupný tlak 8-10 bar, ► samocentrujúci úchyt, krytky pre ALU disky, ► zosilnené guľičkové ložiská a elektromotor s plynule regulovateľnými otáčkami pre otáčanie kolesa ► hlučnosť 75db, váha 987 kg



EVERTBP590

### EVERT



#### Vyvažovačka kolies pre nákladné vozidlá

► Napätie: 230 V, Výkon motora: 370.0 kW  
► Veľkosť ráfika: 8.0" - 28.0"  
► Maximálny priemer kolesa: 1250.0 mm  
► Šírka: 20.0" - 2.0"  
► maximálna váha kolesa: 200.0 kg  
► Režim CAR, Režim SUV, Režim TRUCK,  
► funkcia skrývania závažia



EVERTBP46



#### Diagnostika JALTEST TRUCK, TRUCK + TRAILER

- profesionálna diagnostika pre nákladné automobily - najkomplexnejšia Truck diagnostika na trhu, - verzia TRAILER so softvérom pre návesy a prívesy - v cene je odovzdanie, inštalácia a zaškolenie obsluhy, - možno objednať bez PC (reparovaný HP 840 G1/G2, záruka 24M) - SW na autobusy, návesy, dodávky, agri, alebo komplet, - príkladová sada: základný HW 29365, SW, reparovaný notebook, - aktualizácie SW 3x do roka ( Február / Jún / Október)  
**Obj. č. 29365JPM:** Diagnostika Jaltest TRUCK + TRAILER



29365



#### Dielenský vozík TRUCK - 448 ks

8 zásuviek s centrálnym zámkom a zaistením proti otvoreniu viac ako jednej zásuvky, - 450ks najpoužívanejších náradí pre dodávkové a nákladné automobily, guľičkové ložiská zásuviek, - 2 pevné, 2 otočné kolieska s brzdou, - bočná priehradka na chémiu, - obsah náradia všetkých vozíkov na [www.vybaveniedielni.sk](http://www.vybaveniedielni.sk)



9918HQ-GTT450



#### Dielenský vozík TRUCK GTT520 - 520 ks

8 zásuviek s centrálnym zámkom a zaistením proti otvoreniu viac ako jednej zásuvky, 520ks najpoužívanejších náradí pre dodávkové a nákladné automobily, guľičkové ložiská zásuviek, 2 pevné, 2 otočné kolieska s brzdou, bočná priehradka na chémiu, obsah náradia všetkých vozíkov na [www.vybaveniedielni.sk](http://www.vybaveniedielni.sk)



9918HQ-GTT520



#### BOSCH BAT645 Univerzálna nabíjačka 12/24V

- nabíjací prúd 45A/22,5A pre nabíjanie všetkých typov akumulátorov vrátane gélových, vlietových, AGM, EFB a LFP (lítium-železo-fosfát), - dokáže nabíjať aj silne vybité akumulátory.



0 687 000 164



#### ONE-KEY™ 1" RÁZOVÝ UŤAHOVÁK S RUKOVÄŤOU V TVARE PÍSMENA D, TRECÍM KRÚŽKOM A PREDĹŽENOU NÁKOVOU

Otáčky (ot./min) 600/ 700/ 900/1200  
Počet úderov (ú./min) 750/ 930/ 1200/ 1440  
Max. moment (Nm) 1180/ 1254/ 1966/ 2576  
Max. moment uvoľnenia matic (Nm) 2711  
Hmotnosť s akum. (EPTA) (kg) 12.7 (M18 HB12) | 1 x M18 HB12 akumulátor, M12-18 FC Nabíjačka, Kufrík



4933459733



#### 1" PNEUMATICKÝ RÁZOVÝ UŤAHOVÁK CP7782-6

- max. povoľovací moment 2600 Nm,  
- otáčky 5200 ot/min,  
- pripojovací závit: 1/2"  
- hmotnosť 11,6 kg  
- spotreba 19,2l/s



8941077826



#### Bodový zdvihák 50 ton

Min. výška zdvihu: 280.0 mm  
Max. výška zdvihu: 450.0 mm  
Váha: 26 kg  
Index IC: **0XPTPH0016BP**  
= verzia s nosnosťou 32ton



0XPTPH0063BP



**MAGNETI MARELLI**

**Zlievačko - odsávačka s kontrolnou zbernou nádobou, 80L**

- Nádrž: 80.0 l
- Kapacita kontrolnej zbernej nádoby: 8.0 l
- Odsávanie: Pneumatické
- Váha: 20,5 kg



7935016720

**IDEAL PROFESSIONAL**



**Poloautomatická zväračka MIG/MAG**

- Typ: Invertorový ► Min. zvärací prúd: 30.0 A
- Max. zvärací prúd 250.0 A ► Menovitý výkon: 5.9 kW ► Napájanie: 230 V / 400 V
- Napájanie drôtu: 2-rolkový ► Metóda zvárania: FLUX / MMA / MIG-MAG
- Rozmery DxŠxV: 800x280x540mm
- Hmotnosť: 26.3 kg



TMIG250/2V2

**PROFITOOL**



**Fréza na prehíbanie dezénu pneumatik (TRUCK)**

- napájanie 230V
- maximálny výkon 350W
- 20 nožov v súpave TRUCK



OXTY047

**OTTO HS**



**Kanálový zdvihák**

Individuálna objednávka, výroba na mieru - dodanie 8-10 týždňov. Pre preverenie aktuálnej doby dodania kontaktujte svojho OTZ. V ponuke sú aj hydraulické verzie s ručným pohonom (verzie WWr) alebo elektro-hydraulické (verzie WWe). Celú ponuku nájdete v online katalógu E-cat.

Index IC: **PK/WW-10** - nosn. 10 ton

Index IC: **PK/WW-12** - nosn. 12 ton

Index IC: **PK/WW-15** - nosn. 15 ton



PK/WW-10

**Milwaukee**



**1" NÁSTRČNÉ KLÚČE SHOCKWAVE™ IMPACT DUTY**

Oceľ SHOCKWAVE™ IMPACT DUTY (chróm-molybdén) je vysoko kvalitná legovaná oceľ, ktorá poskytuje najvyššiu pevnosť a odolnosť.

**V ponuke rôzne veľkosti od 27-70.**



4932480408

**DAWELL**



**Indukčný ohrev DHI44**

**DAWELL** - uvoľnenie skrutiek, matíc, spojov, opalovanie starého náteru, atď., - regulácia výkonu 10-100%, časovač, vodné chladenie; - kábel 2 m, výkon 3,7 kW, napájanie 230 V, hmotnosť: 11,5 kg; - v balení fokusačná bočná cievka, chladiaca kvapalina 2,5L.



DHI44

**PROFITOOL**



**Posilňovač momentu 1"**

- 5800 Nm, 65:1,
- hlavice 32 a 33 mm



OXAT6021

**MOTIP**



**Čistič brzd MOTIP 12 X 500 ML**



ZE TECH2

**Čistič brzd MOTIP 12 X 750 ML**



ZE TECH1

**Čistič brzd MOTIP KANISTER 5L**



V60563

**Čistič brzd MOTIP SUD 60L**



V60563

**PROFITOOL**



**Pasta na umývanie silne znečistených rúk**

- objem: 10 l, zloženie: tuhé,
- vôňa: mandľová, farba: ružová
- 1305-01-0002E = verzia 5l balenia



1305-01-0003E



# INTER CARS

## POBOČKY INTER CARS NA SLOVENSKU

### Banská Bystrica

Inter Cars  
Zvolenská cesta 46/B  
974 05 Banská Bystrica  
048/3260 222  
banska.bystrica@intercars.sk

### Bardejov

Inter Cars  
Duklianska 16  
085 01 Bardejov  
054/3260 222  
bardejov@intercars.sk

### Bratislava

Inter Cars  
Ivánska cesta 2  
821 04 Bratislava  
02/3260 2222  
bratislava@intercars.sk

### Dunajská Streda

Inter Cars  
Hlavná 7795/90A  
929 01 Dunajská Streda  
031/3260 222  
dunajska.streda@intercars.sk

### Humenné

Inter Cars  
Mierová ulica 62  
066 01 Humenné  
057/3260 222  
humenne@intercars.sk

### Košice

Inter Cars  
Južná trieda 82  
040 17 Košice  
055/3260 220  
kosice@intercars.sk

### Levice

Inter Cars  
Jurská cesta 6  
934 01 Levice  
036/3260 222  
levice@intercars.sk

### Lučenec

Inter Cars  
ul. Alojza Jiráska 5361/12  
984 01 Lucenec  
047/3260 222  
lucenec@intercars.sk

### Malacky

Inter Cars  
Priemyselná 5863  
901 01 Malacky  
034/3260 222  
malacky@intercars.sk

### Michalovce

Inter Cars  
Močarianska 15  
071 01 Michalovce  
056/32 60 222  
michalovce@intercars.eu

### Námestovo

Inter Cars  
Vavrečka 487  
029 01 Námestovo  
043/3260 222  
namestovo@intercars.eu

### Nitra

Inter Cars  
Bratislavská 25  
949 01 Nitra  
037/3260 222  
nitra@intercars.sk

### Nové Zámky

Inter Cars  
Ďumbierska 4  
940 01 Nové Zámky  
035/3260 222  
nove.zamky@intercars.sk

### Piešťany

Inter Cars  
Ul. Fraňa Kráľa 1915/2  
92203 Vrbové  
033/3260 272  
piestany@intercars.sk

### Poprad

Inter Cars  
Hraničná 26  
058 01 Poprad  
052/3260 222  
poprad@intercars.sk

### Prešov - Záborské

Inter Cars  
Záborské 516  
082 53 Záborské – Prešov  
051/3260 222  
presov@intercars.sk

### Prievidza

Inter Cars  
Necpálska cesta 34C  
971 01 Prievidza  
046/3260 222  
prievidza@intercars.sk

### Rožňava

Inter Cars  
Pavla Dobšínskeho 1905/11  
048 01 Rožňava  
058/3260 222  
roznava@intercars.sk

### Ružomberok

Inter Cars  
Bystrická cesta 5116  
034 01 Ružomberok  
044/3260 222  
ruzomberok@intercars.sk

### Senec

Inter Cars  
Pezinská cesta 30 (areál Trios)  
903 01 Senec  
02/3260 2231-2  
senec@intercars.sk

### Senica

Inter Cars  
Priemyselná 14  
905 01 Senica  
+421 34 326 0272  
senica@intercars.eu

### Spišská Nová Ves

Inter Cars  
Duklianska 36  
052 01 Spišská Nová Ves  
053/3260 222  
snv@intercars.eu

### Sučany

Inter Cars  
Stará Prefa 2289/7  
03852 Sučany  
043/3260 241  
martin@intercars.eu

### Trenčín

Inter Cars  
Zlatovská 2416  
911 05 Trenčín  
032/3260 222  
trencin@intercars.sk

### Trnava

Inter Cars  
Zlievarenská 8130/5  
917 02 Trnava  
033/3260 222  
trnava@intercars.sk

### Zvolen

Inter Cars  
Bystrická 26/a  
962 37 Kováčová  
045/3260 222  
zvolen@intercars.sk

### Žilina

Inter Cars  
Kragujevská 1  
010 01 Žilina  
041/3260 222  
zilina@intercars.sk